

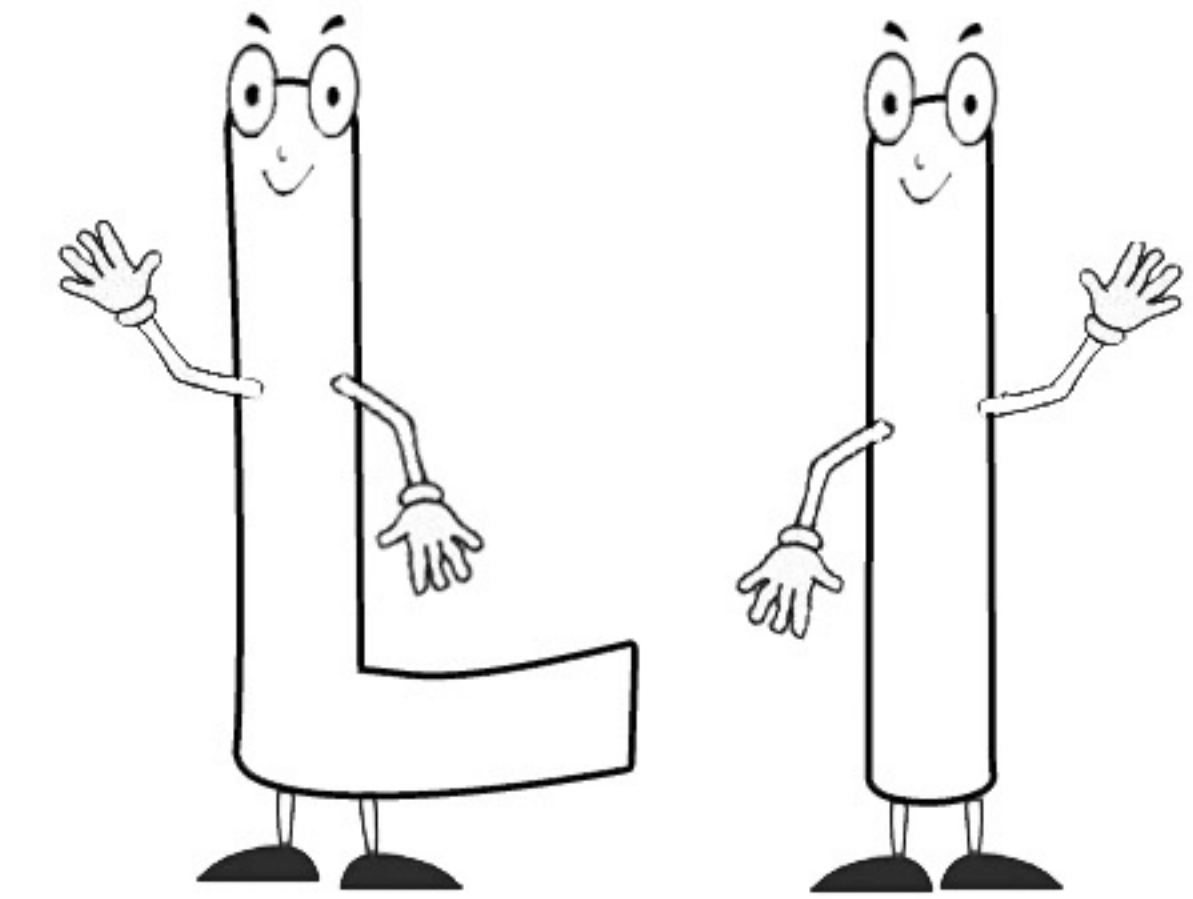

Name \_\_\_\_\_

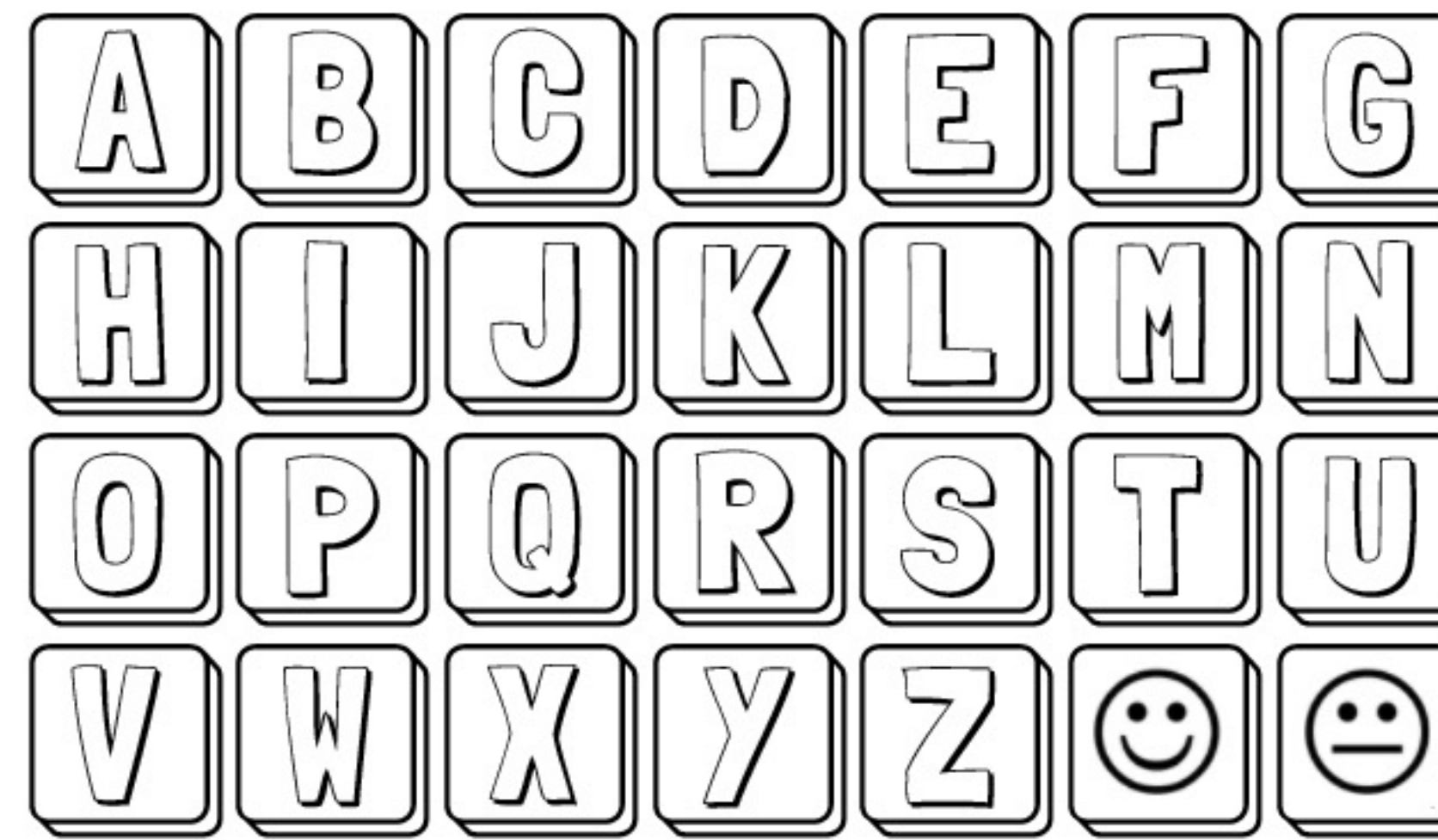

 Circle L and l.

L j K l J k l j K L  
J m l j K L M m l j  
l k M L m J k l L m  
M L j k l m j M k l

 Trace "l". Read the words.

lab leg  
let lit

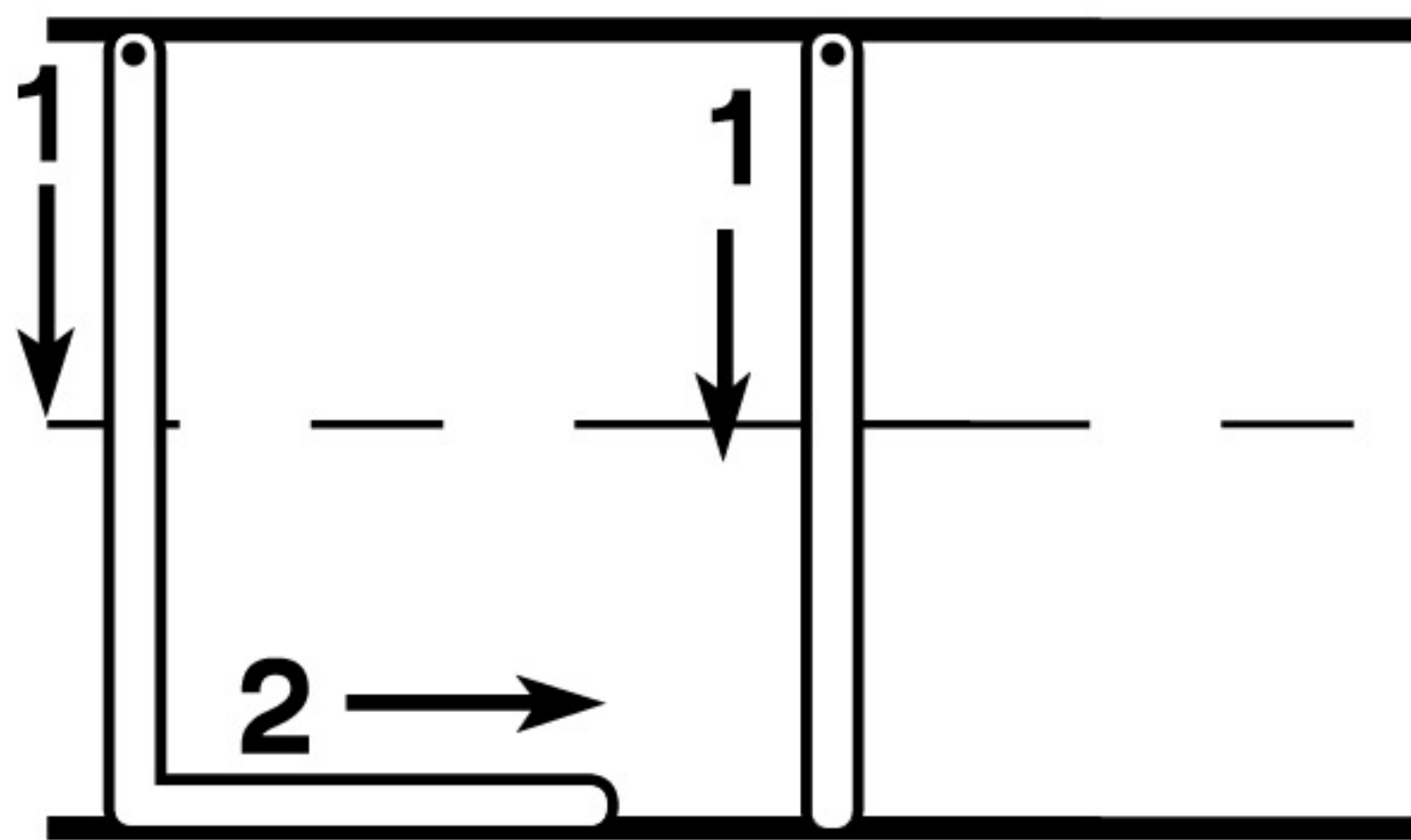

 Trace and write. Follow the numbered arrows.



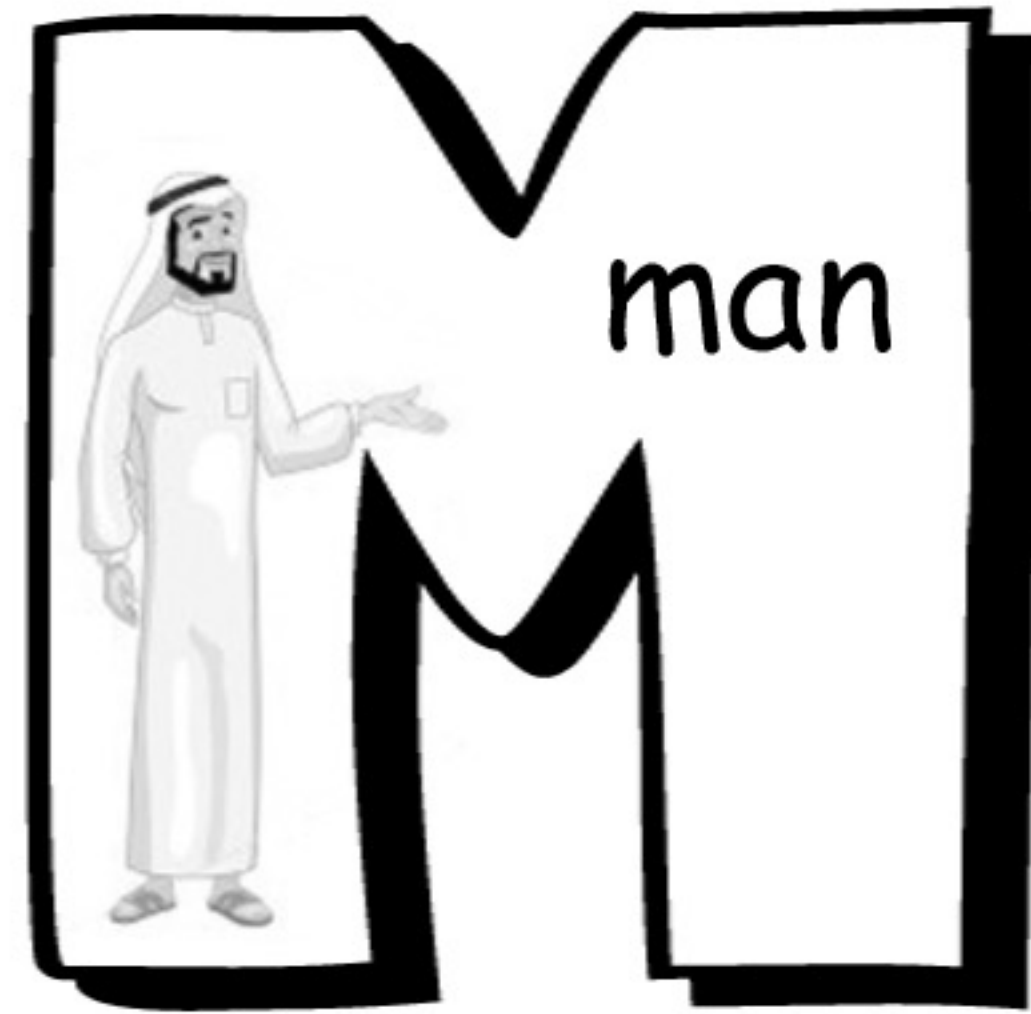

Name \_\_\_\_\_

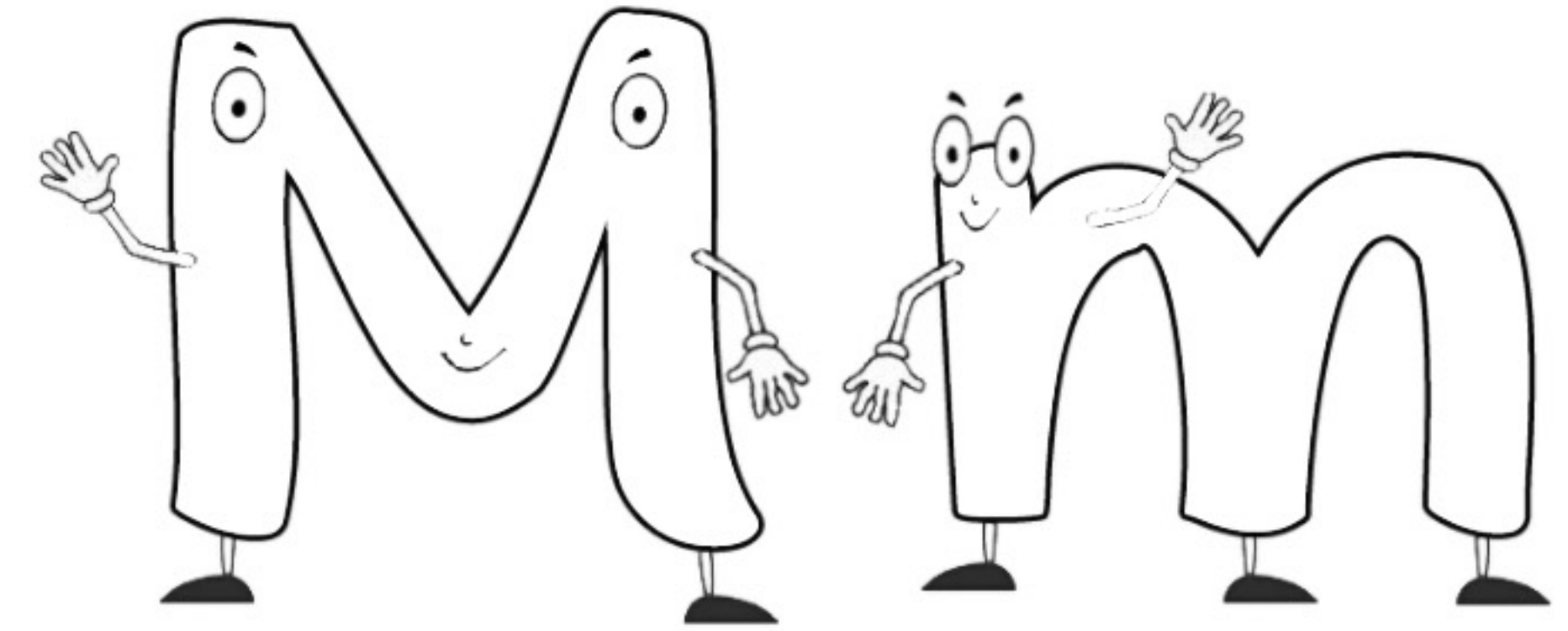
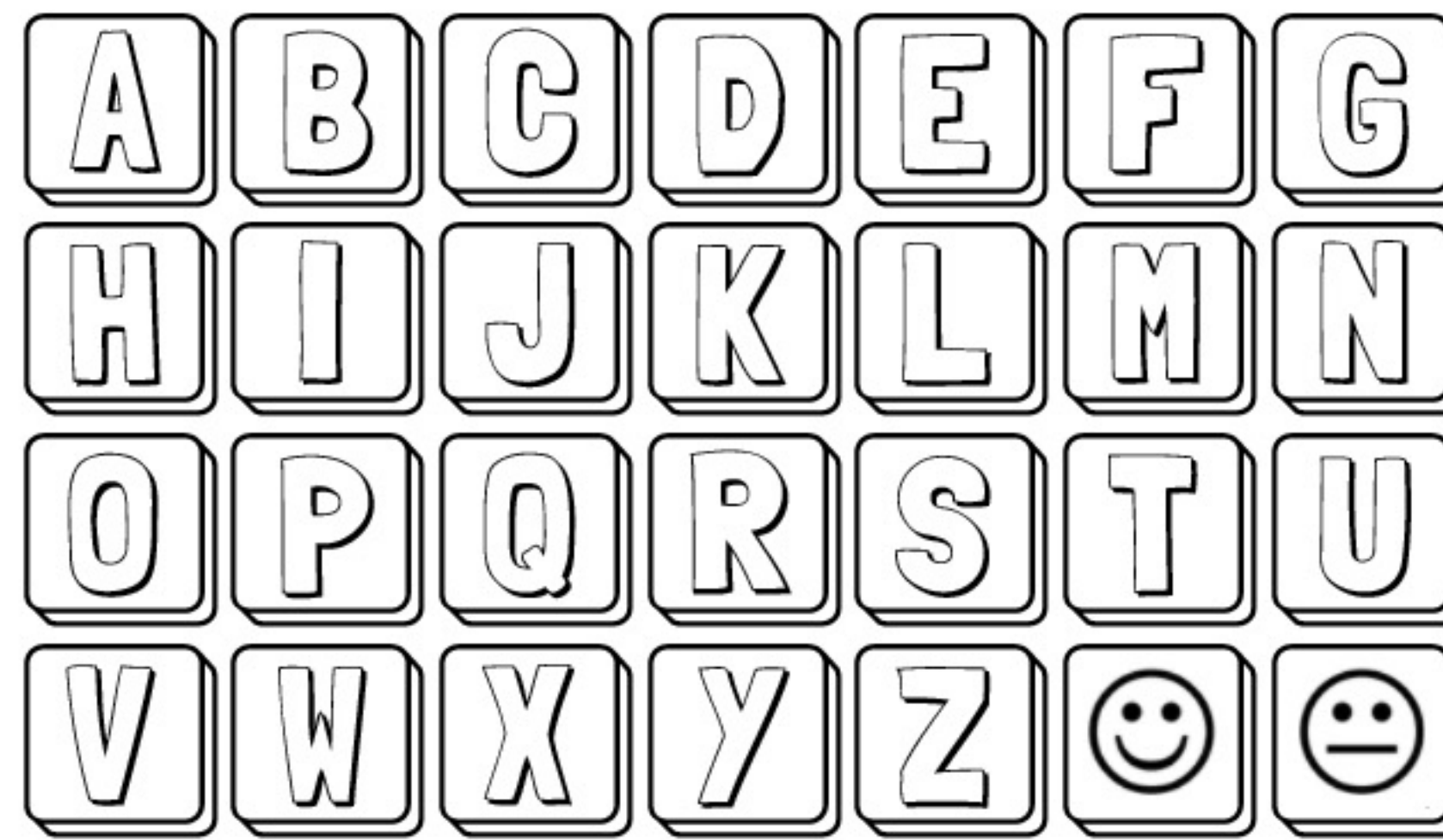

Circle M and m.

M n O m N o m n O M  
N p m n O M P p m n  
m o P M p N o m M p  
P M n o m p n P o m

Trace "m". Read the words.

man mad  
med mid

Trace and write. Follow the numbered arrows.

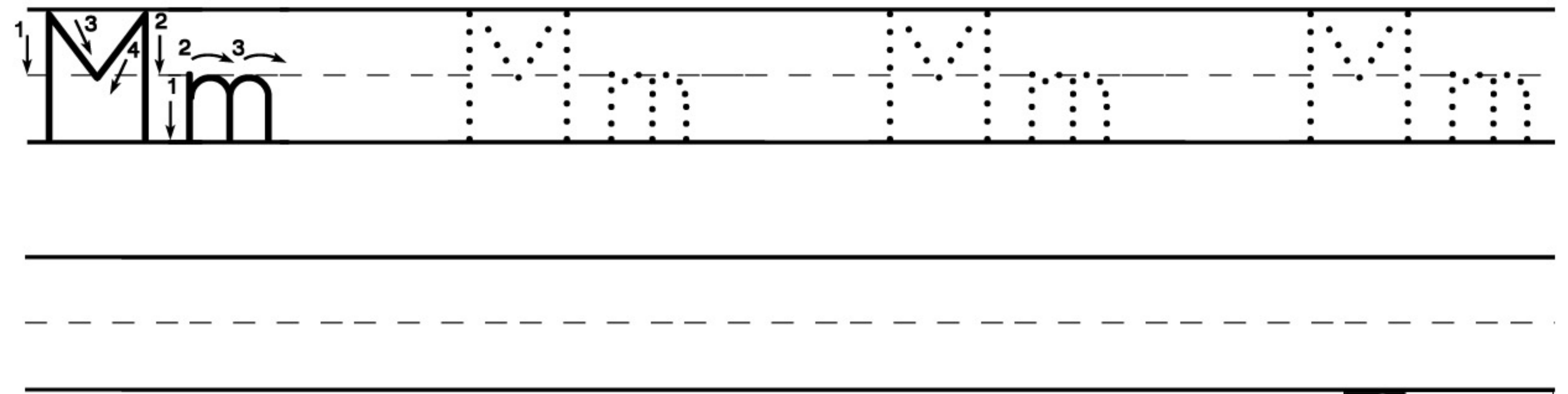
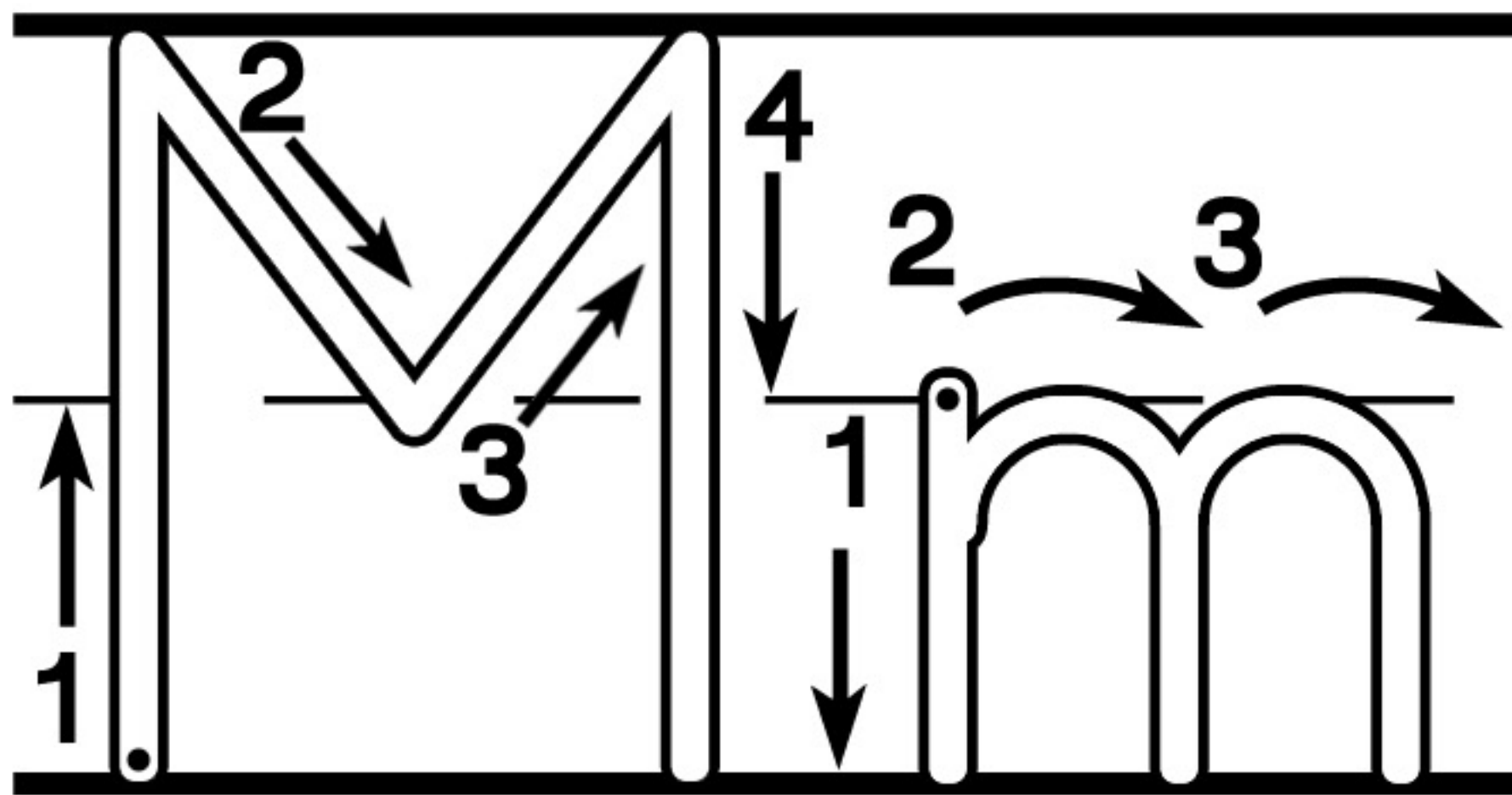

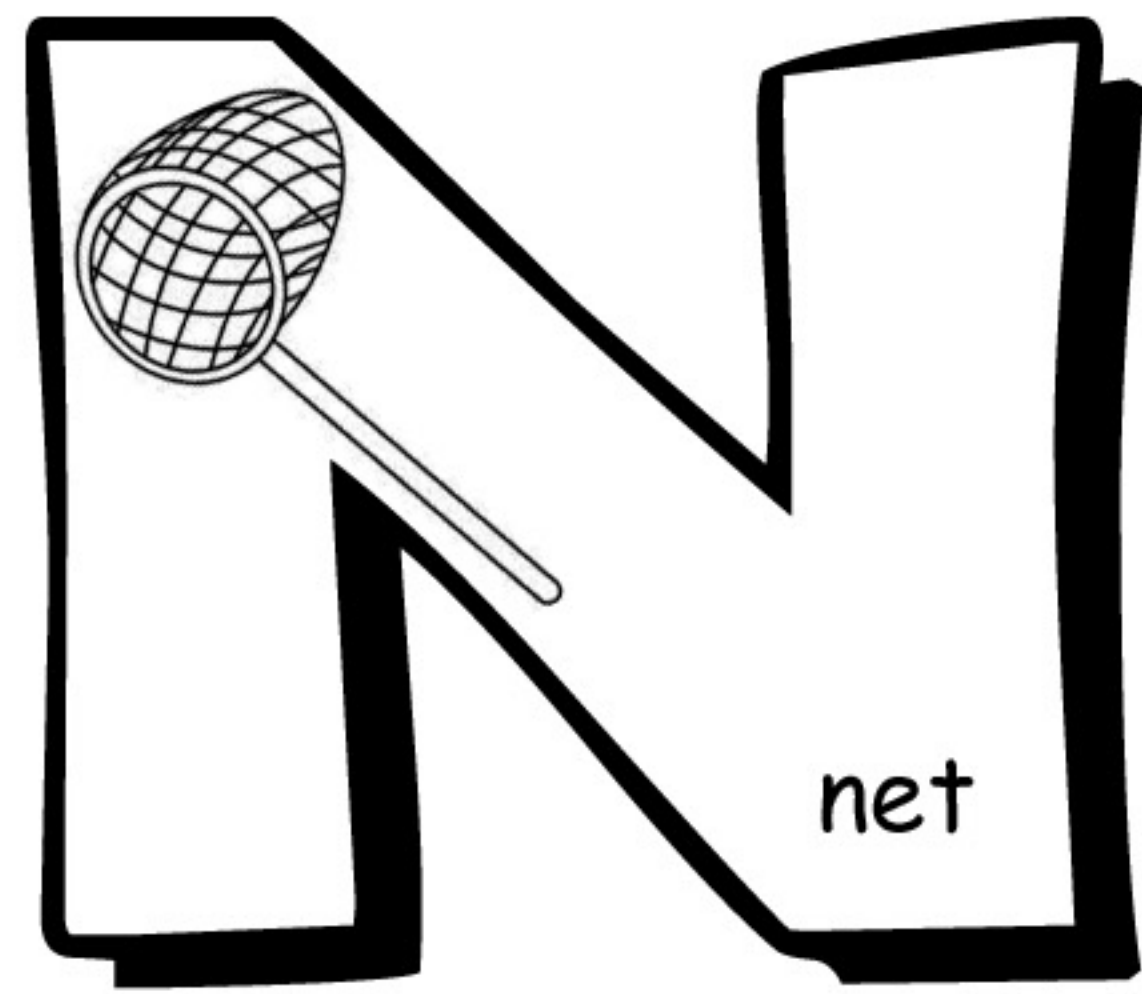

Name \_\_\_\_\_

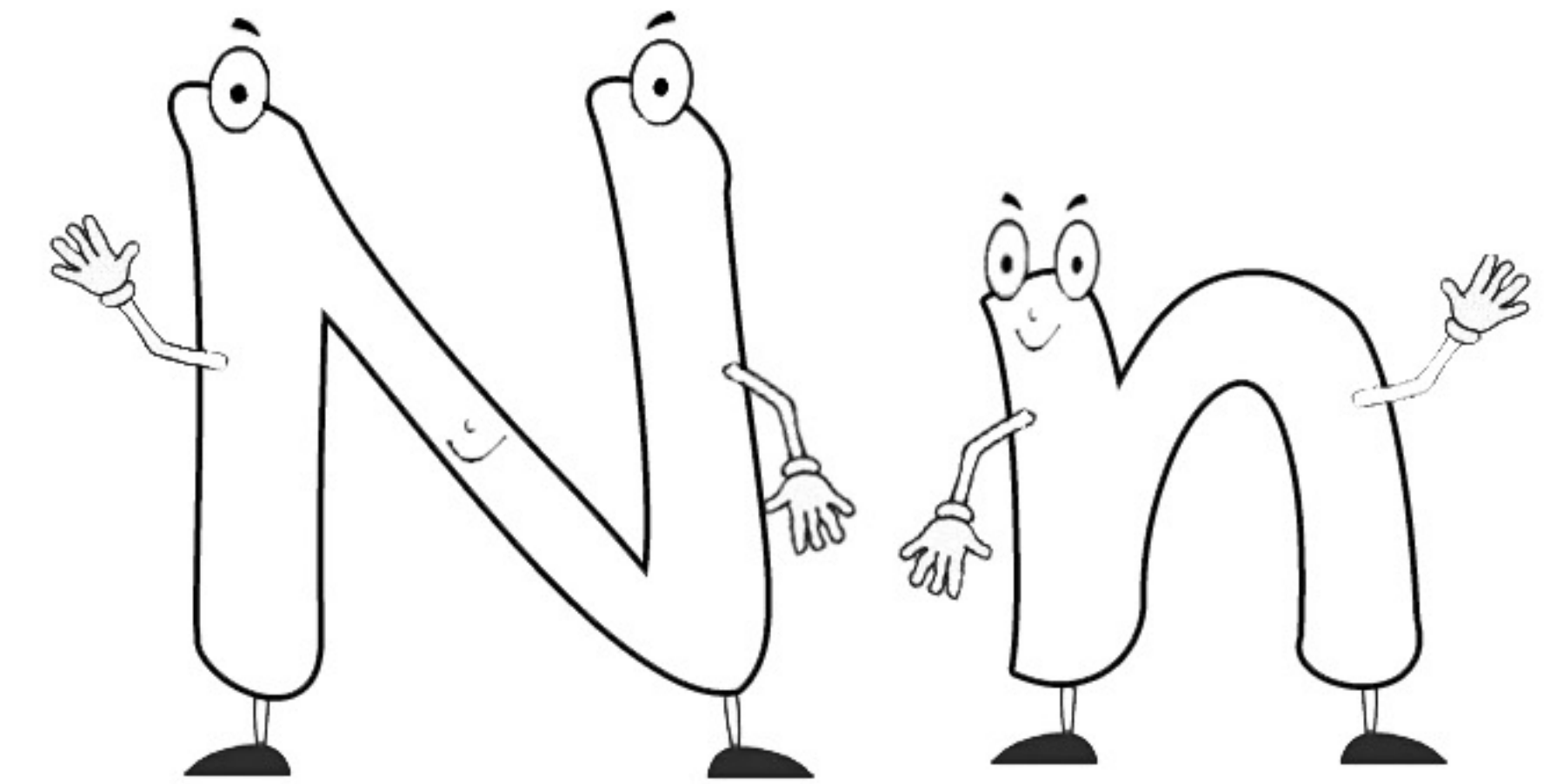
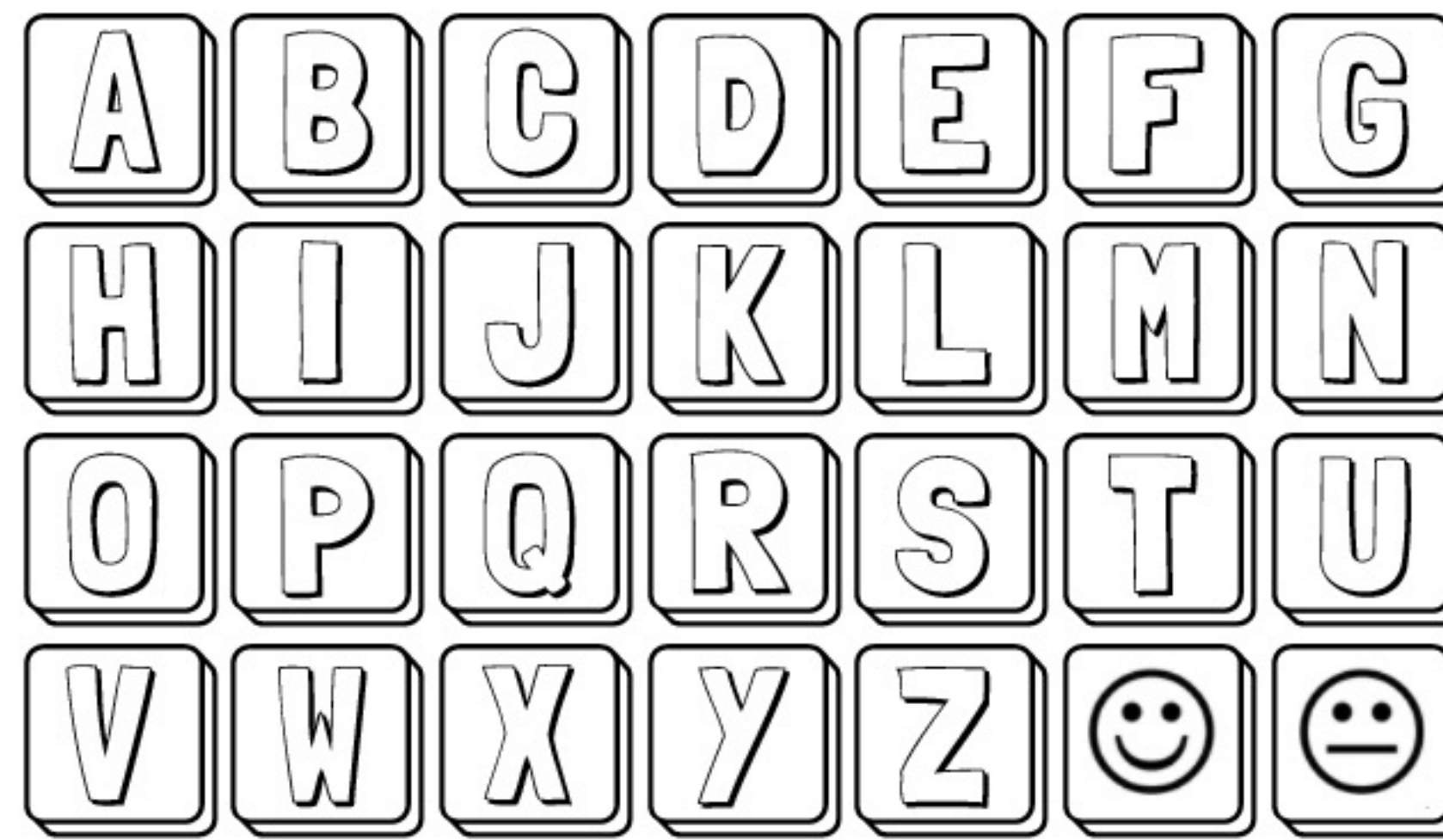

Circle N and n.

N m O n M o n m O N  
M p n m O N P p n m  
n o P N p M o n N p  
P N m o n p m P o n

Trace "n". Read the words.

nap net  
nit nib

Trace and write. Follow the numbered arrows.

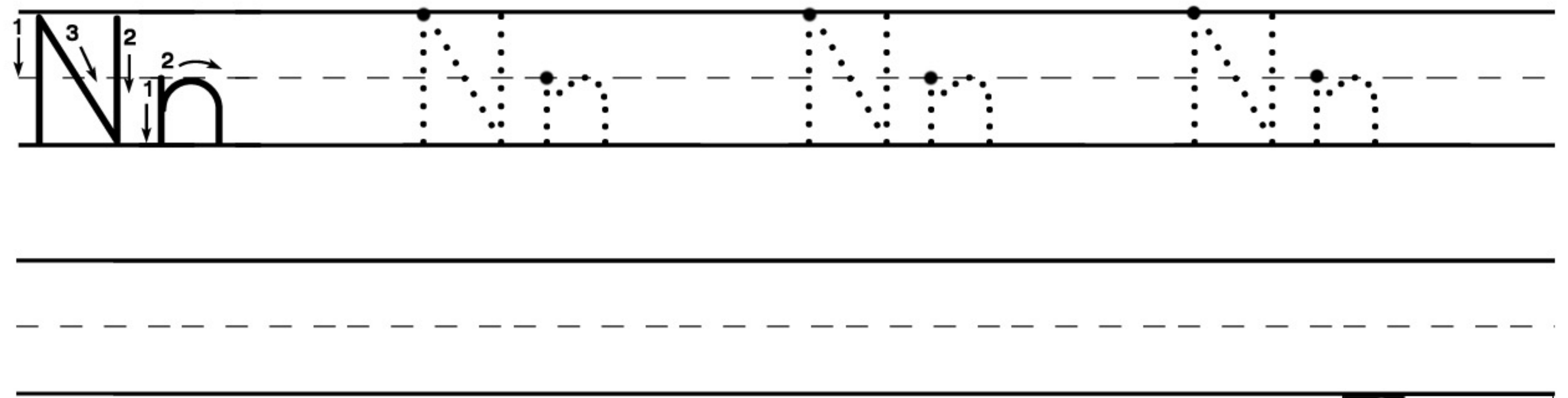
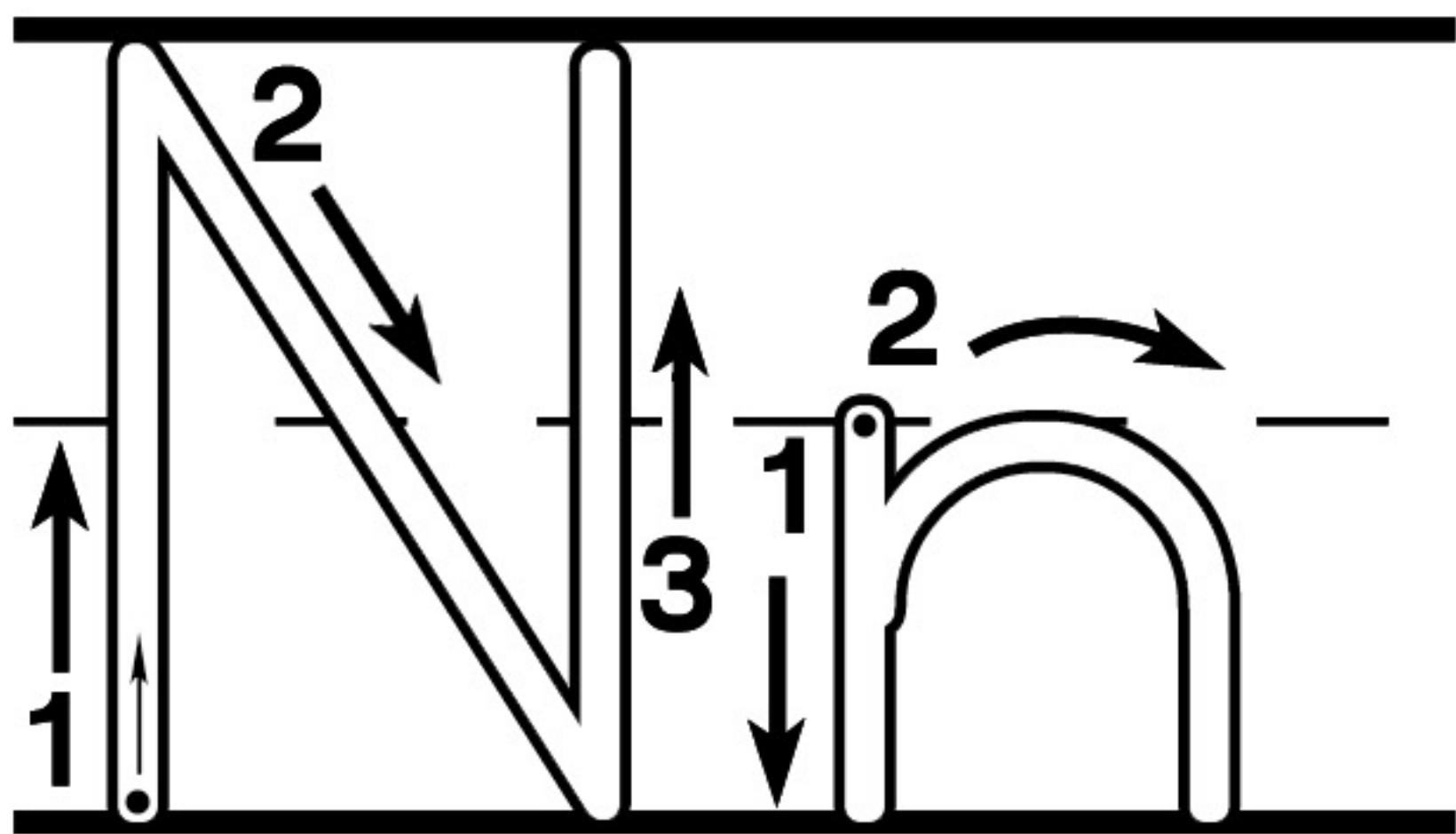

Name \_\_\_\_\_

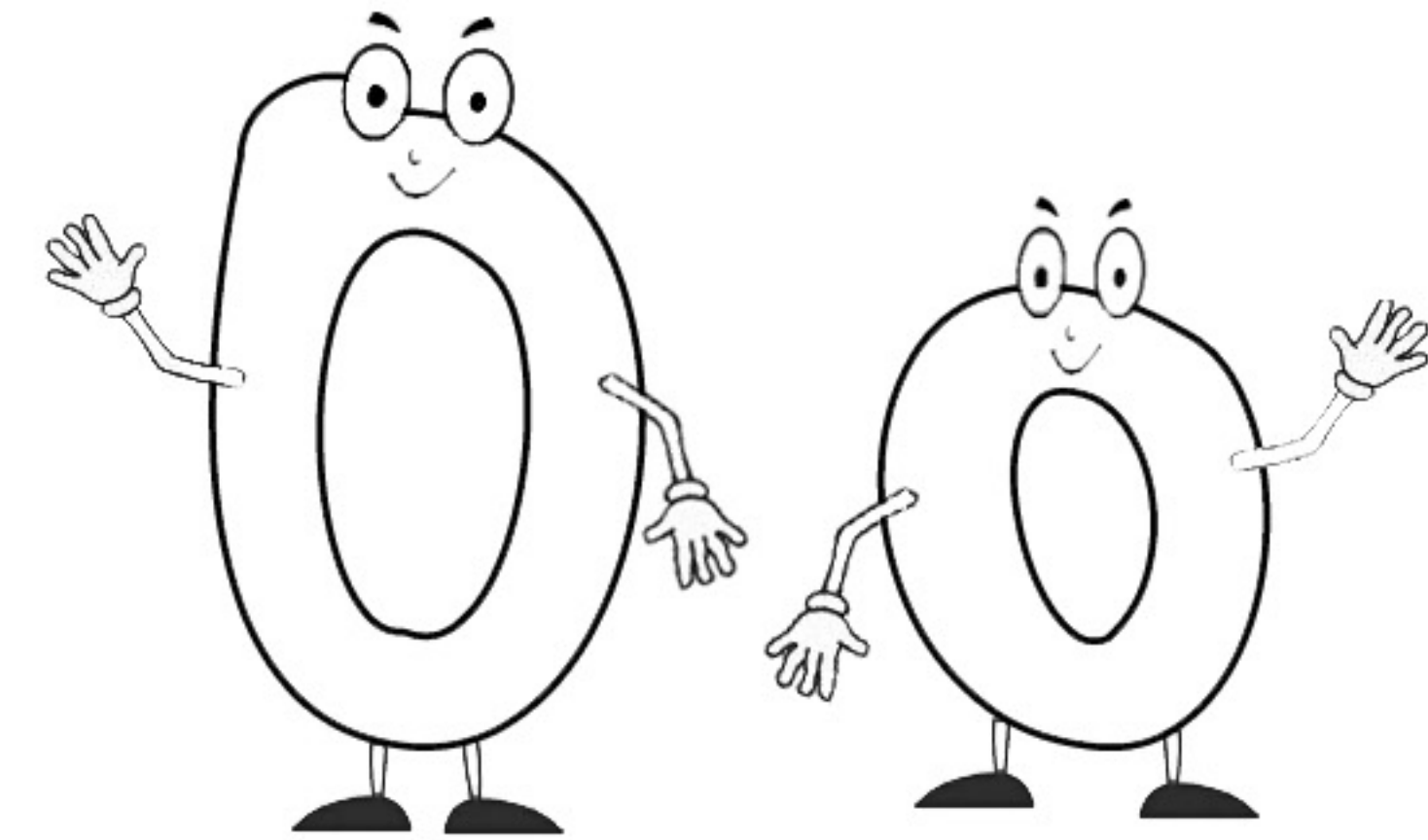
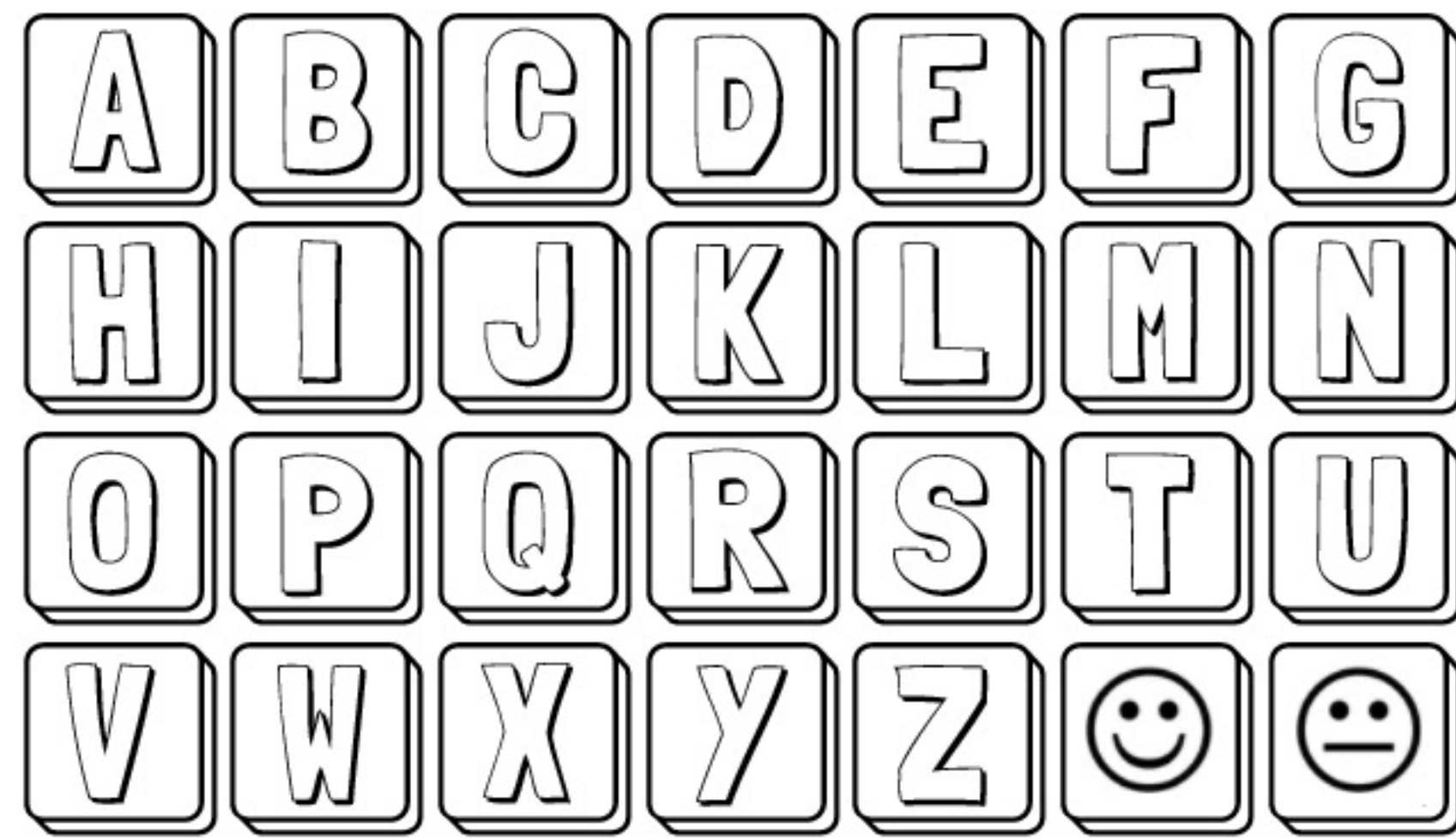
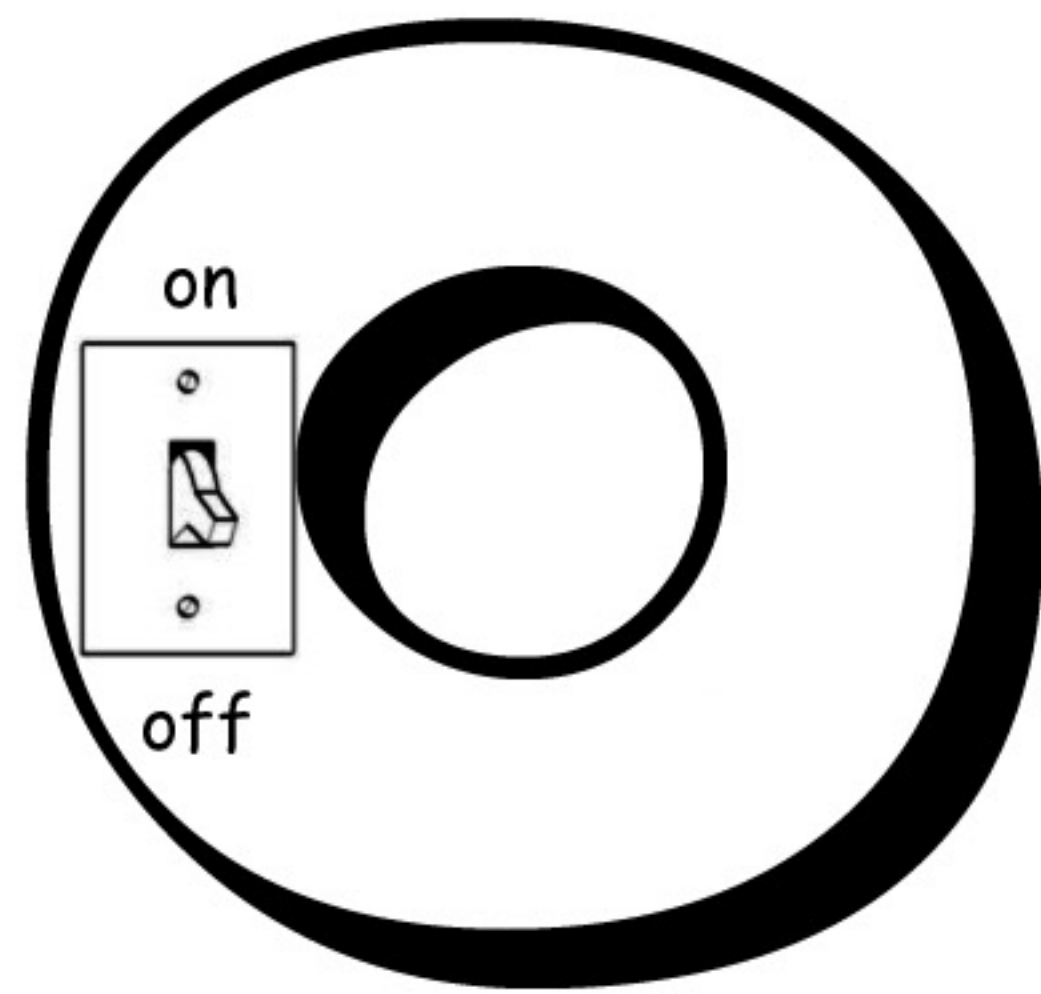

 Circle O and o.

O m N o M n o m N O  
M p o m N O P p o m  
o n P O p M n o O p  
P O m n o p m P n o

 Trace "o". Read the words.

on off  
fog job

 Trace and write. Follow the numbered arrows.

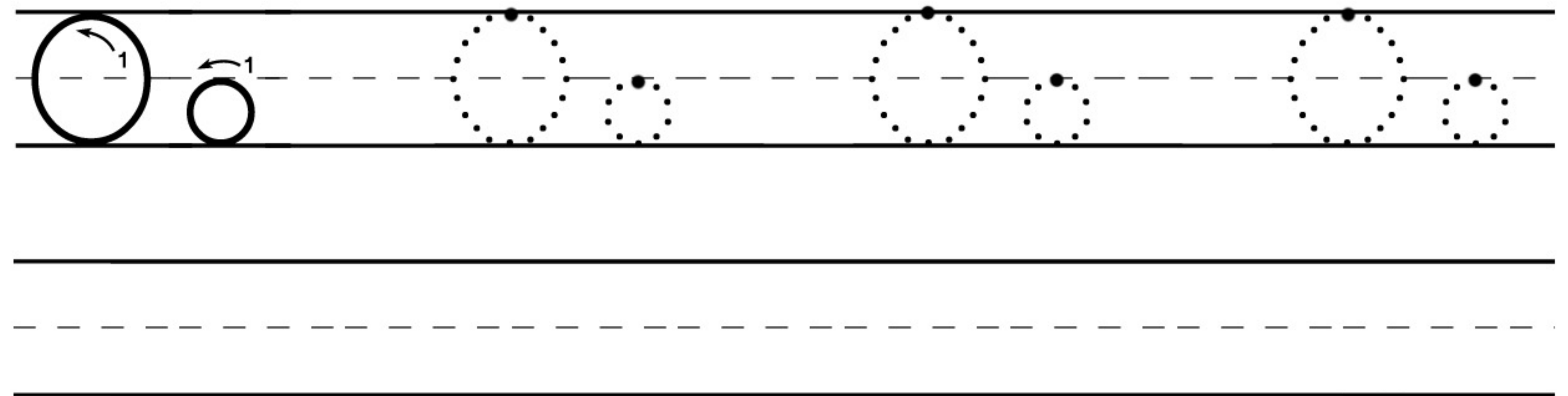
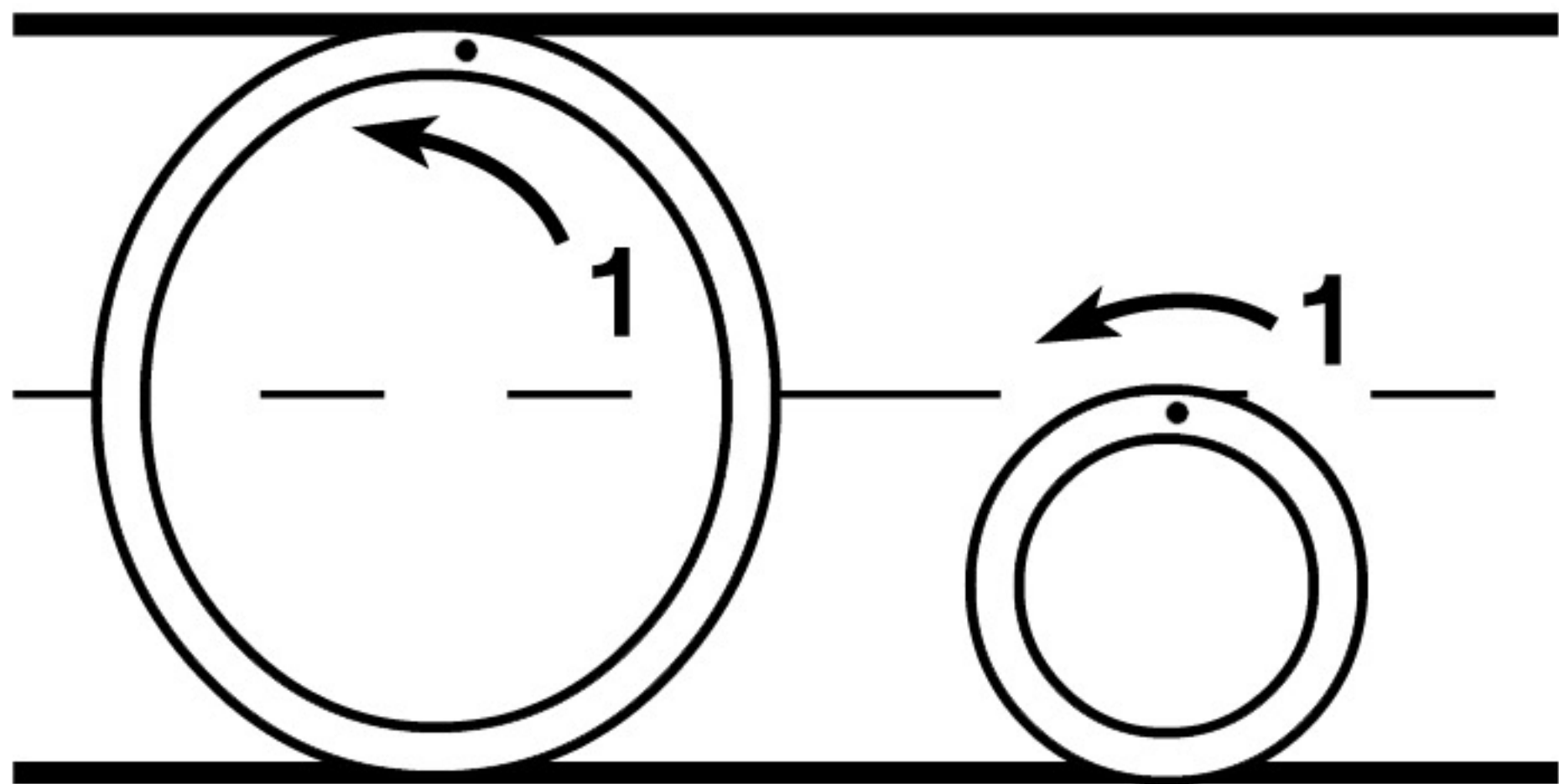

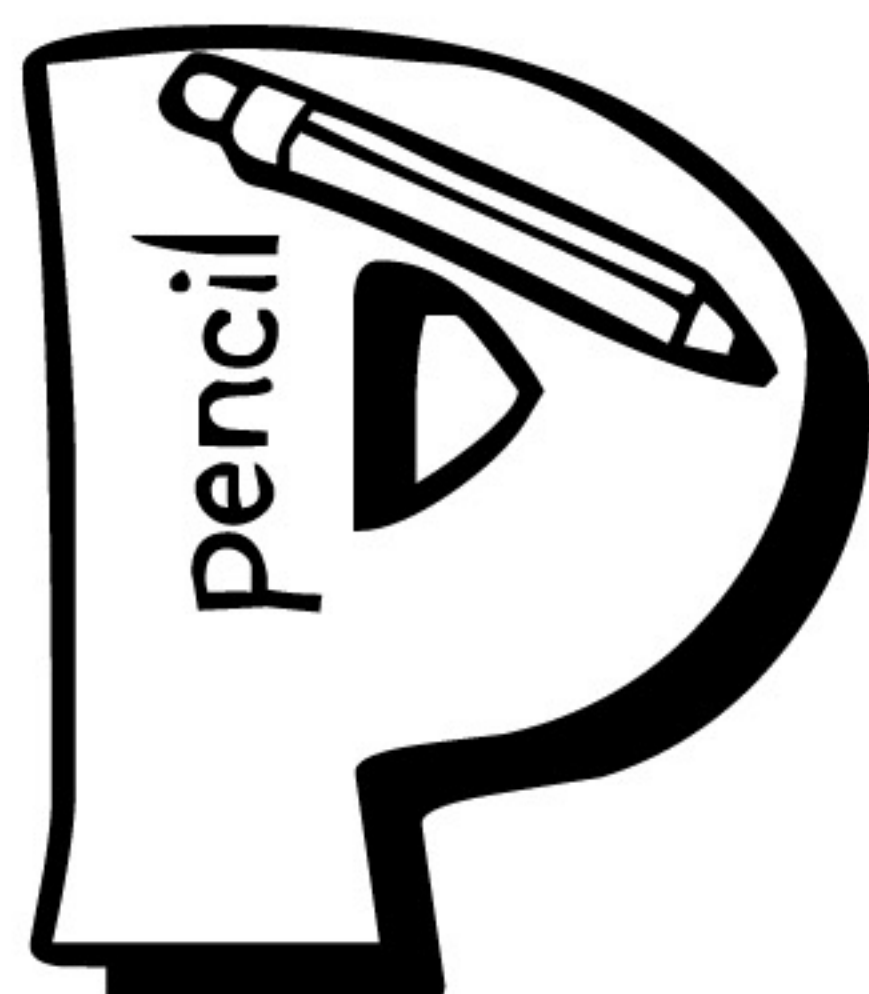

Name \_\_\_\_\_

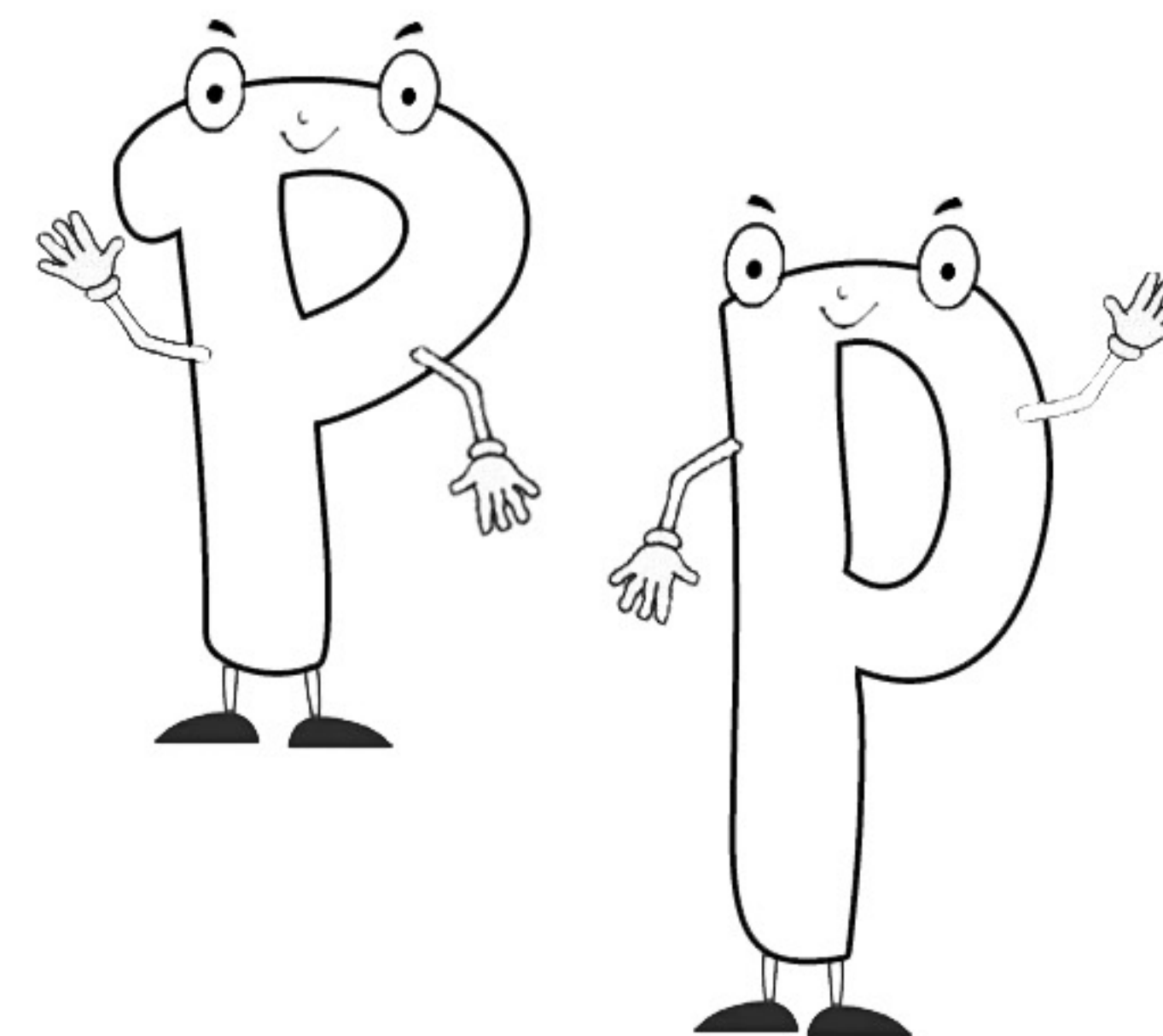
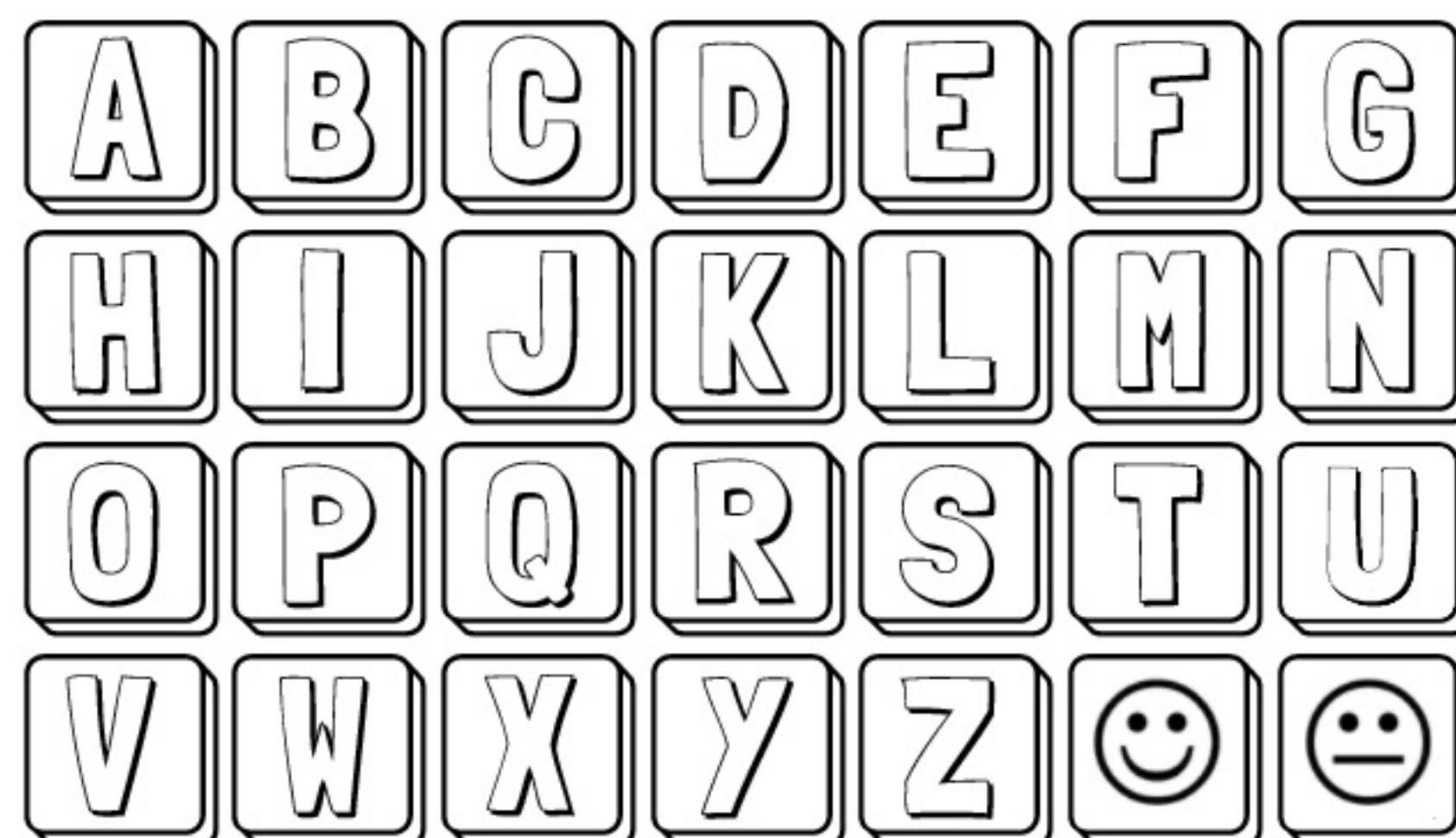

 Circle P and p.

P q R p Q r p q R P  
Q s p q R P S s p q  
p r S P s Q r p P s  
S P q r p s q S r p

 Trace "p". Read the words.

pan

pet

pin

pot

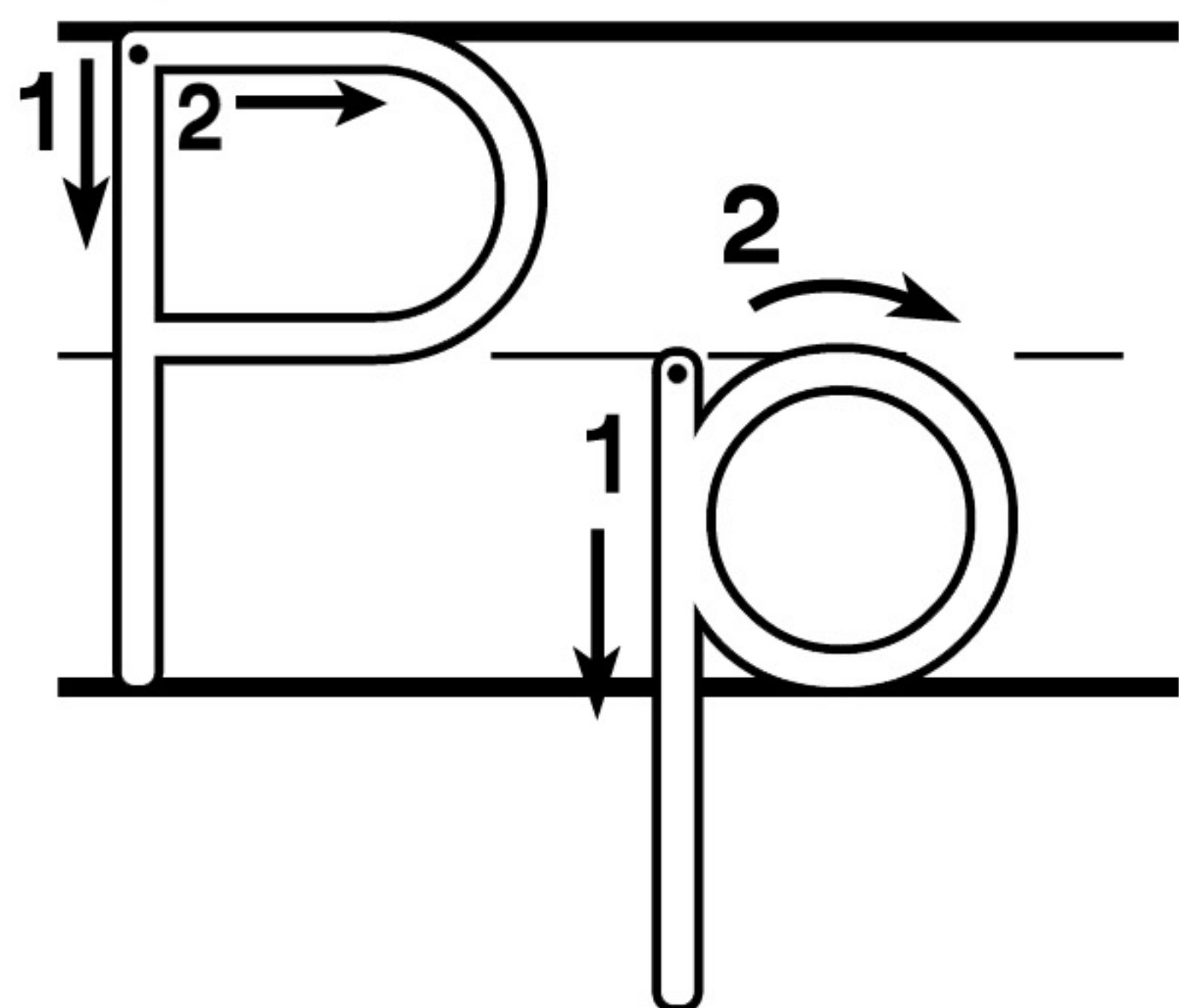

 Trace and write. Follow the numbered arrows.

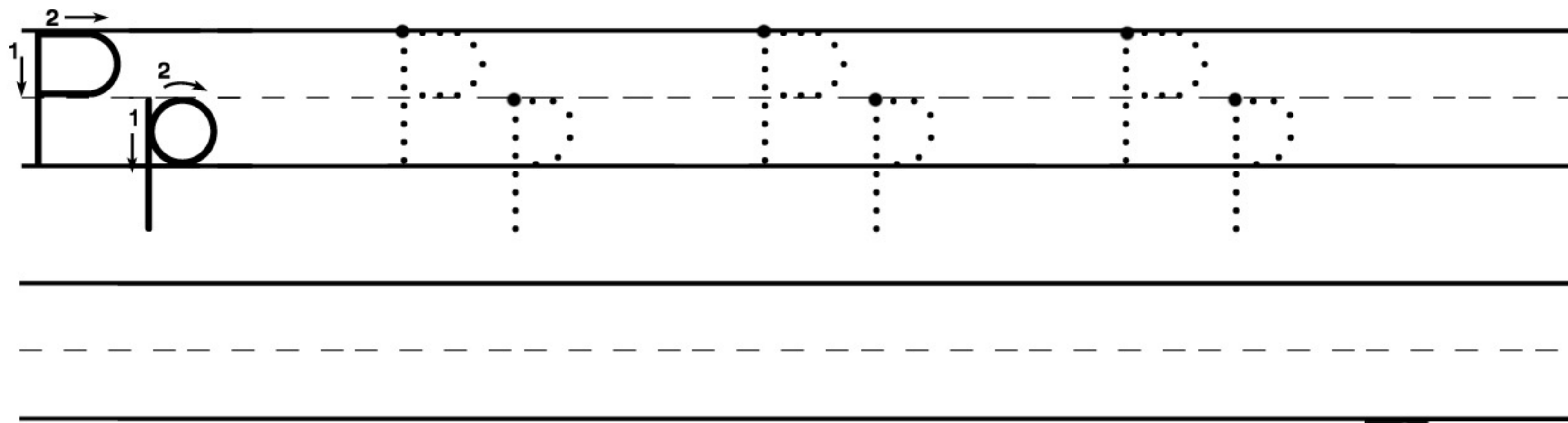

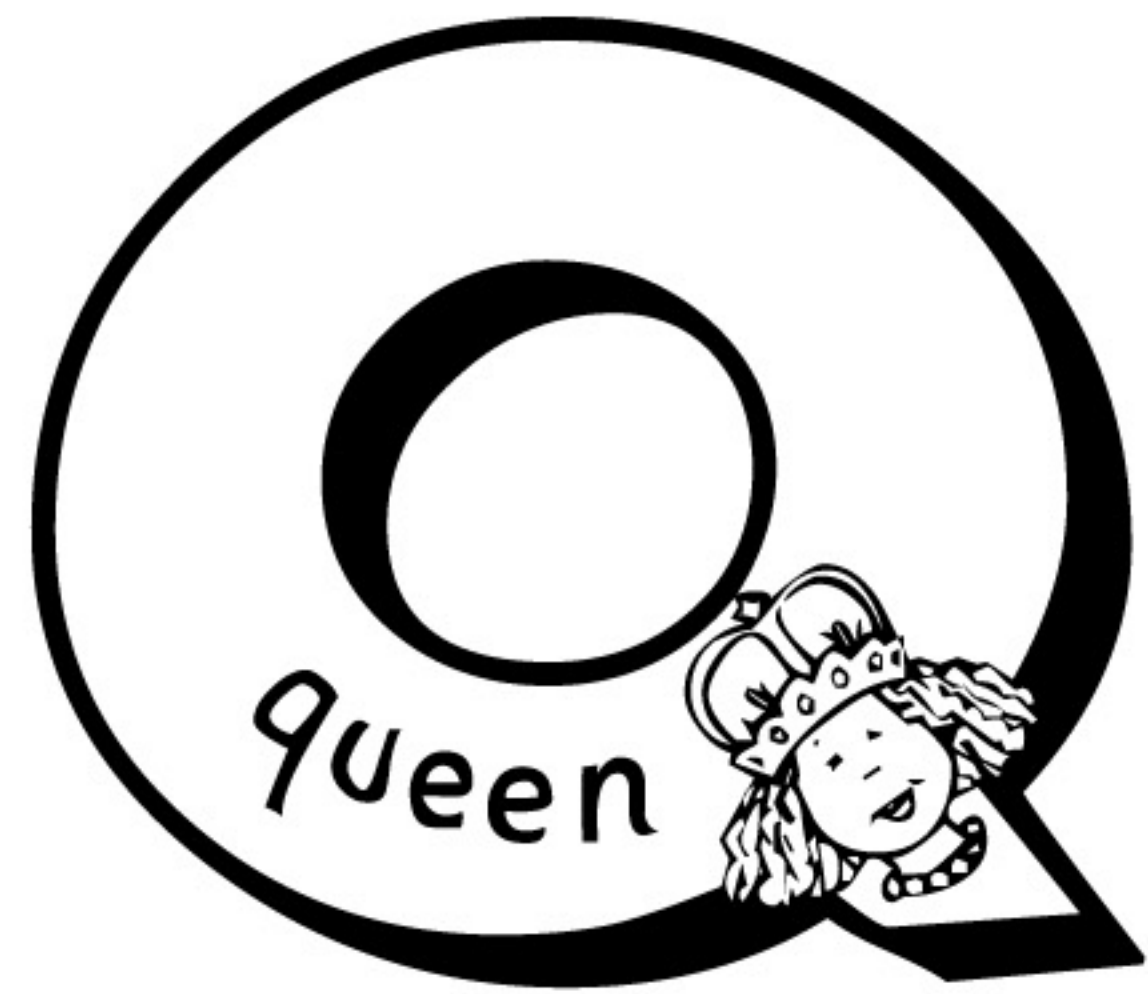

Name \_\_\_\_\_

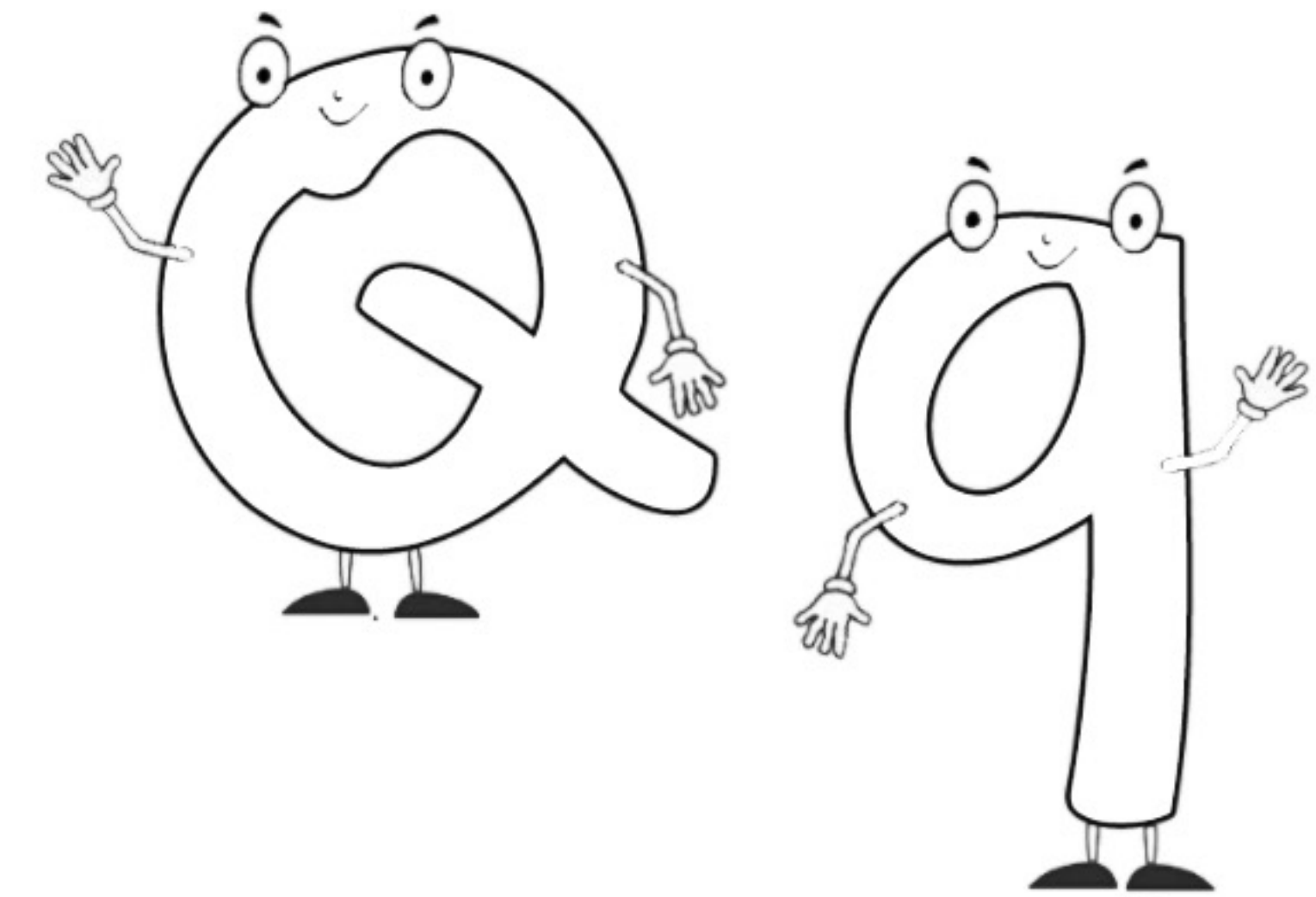
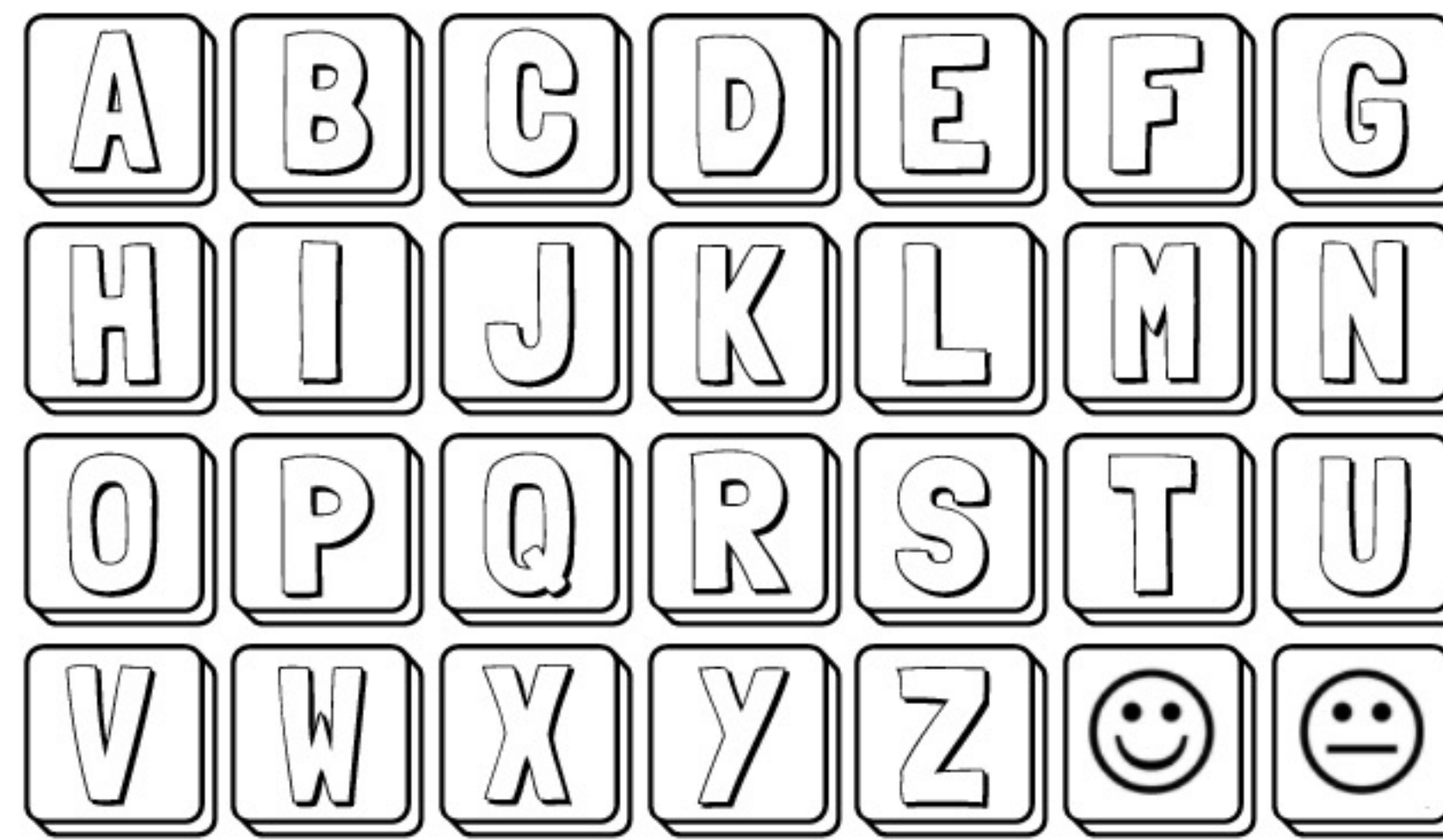

Circle Q and q.

Q p R q P r q p R Q  
P s q p R Q S s q p  
q r S Q s P r q Q s  
S Q p r q s p S r q

Trace "q". Read the words.

queen quit  
queue quiz

Trace and write. Follow the numbered arrows.

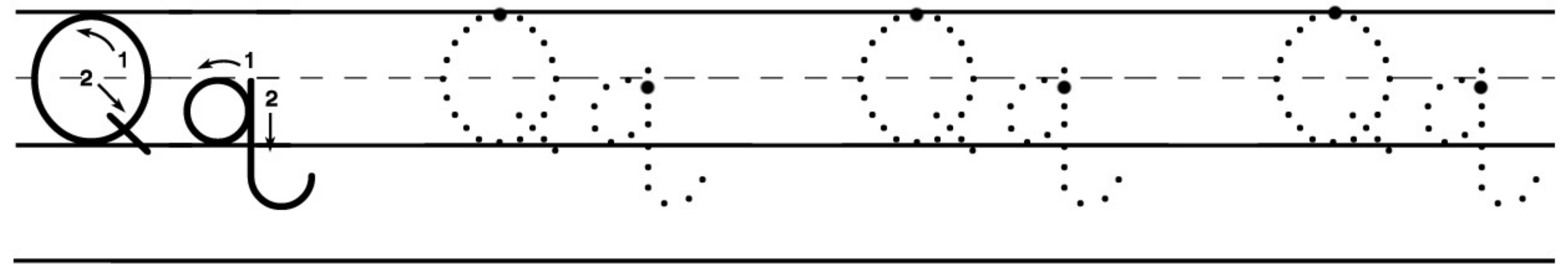
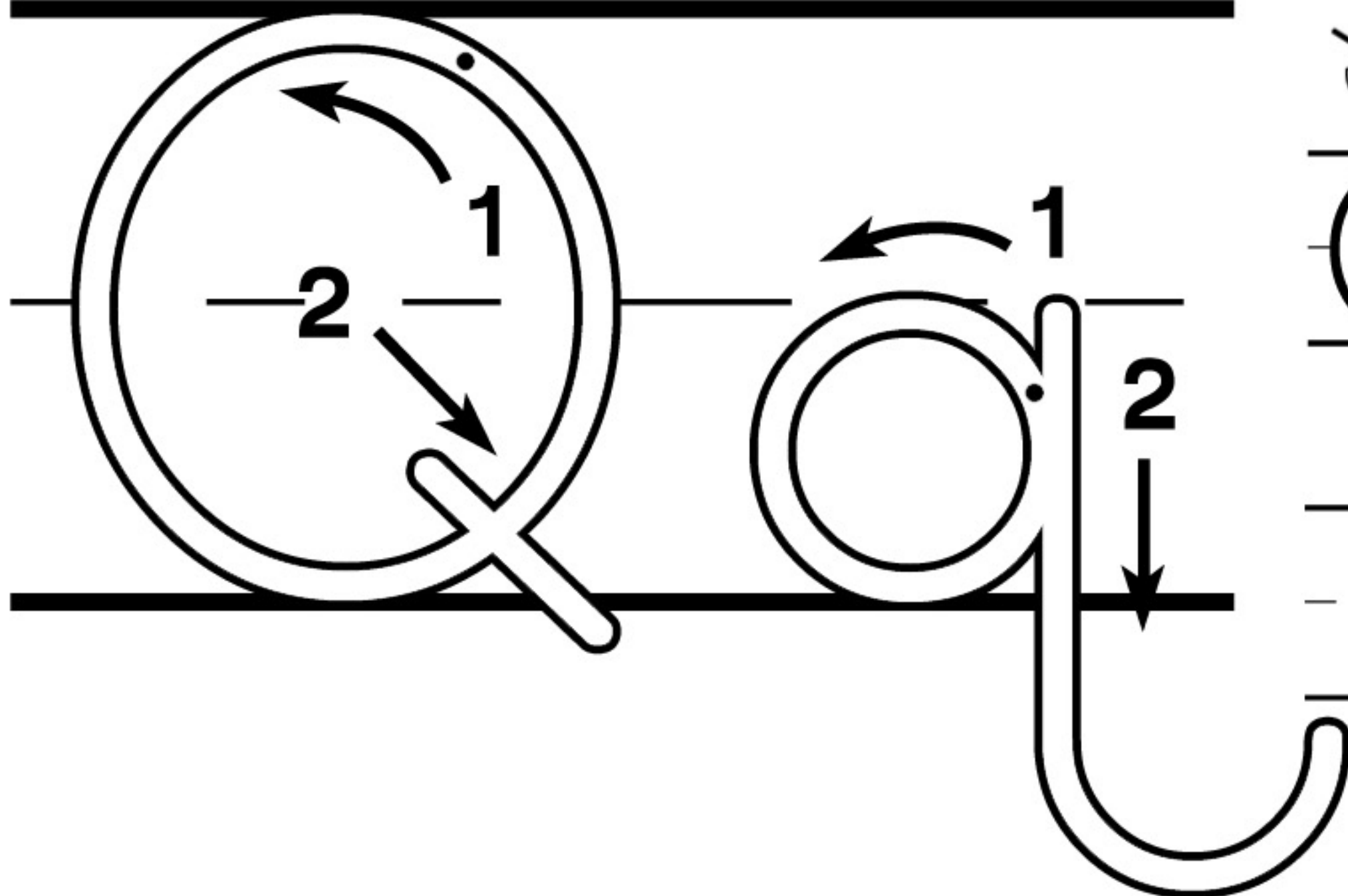

Name \_\_\_\_\_

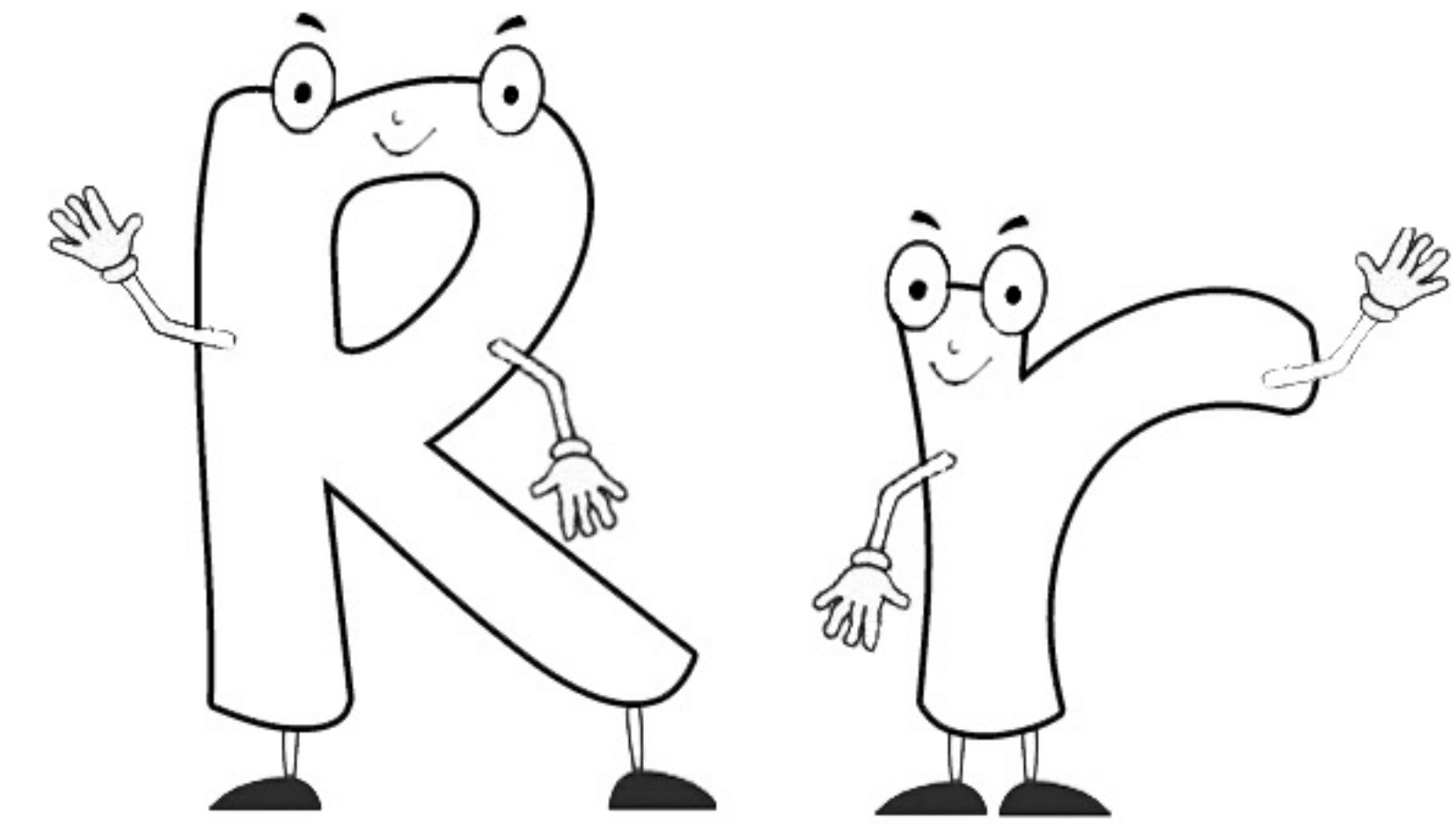
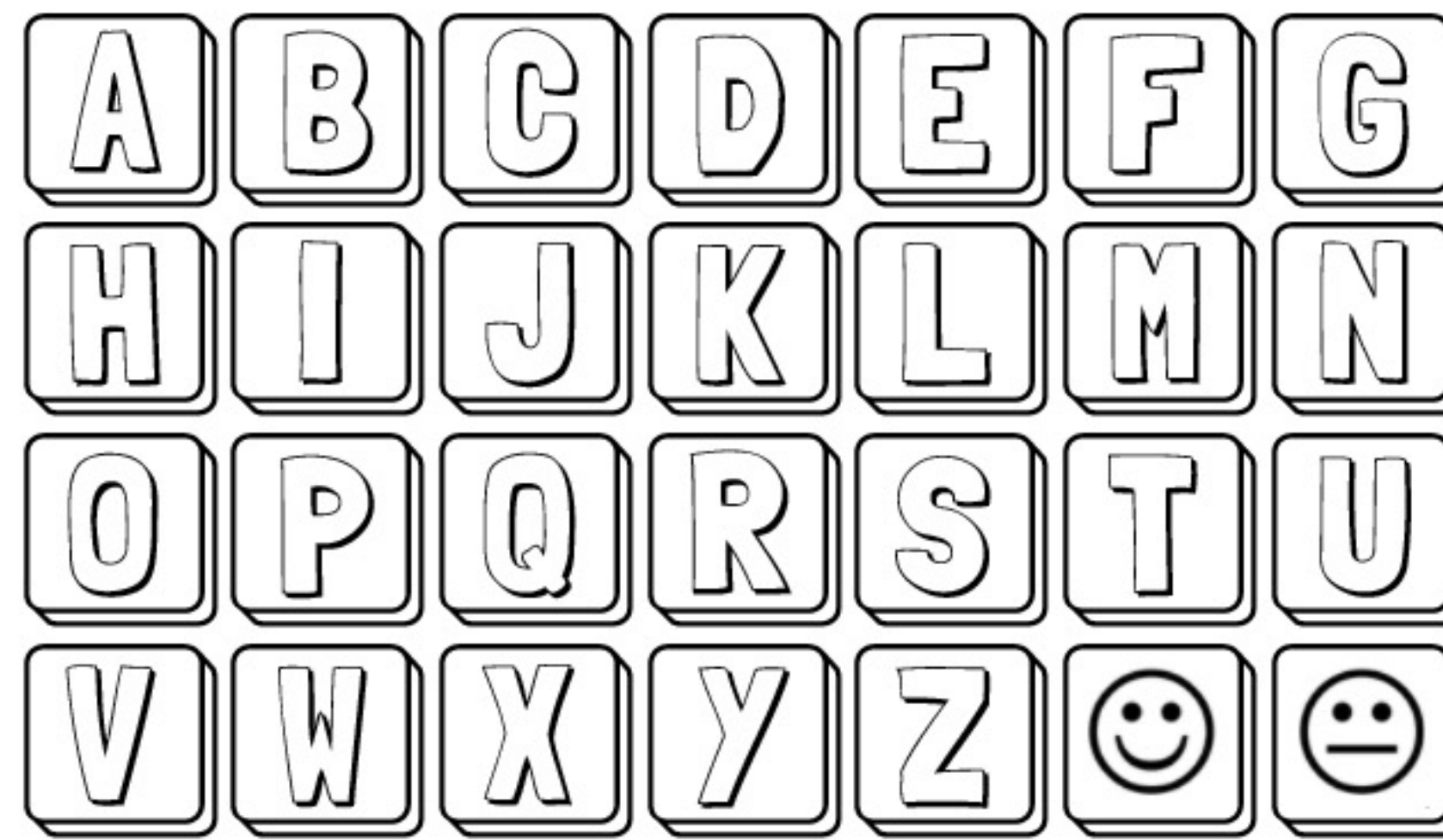
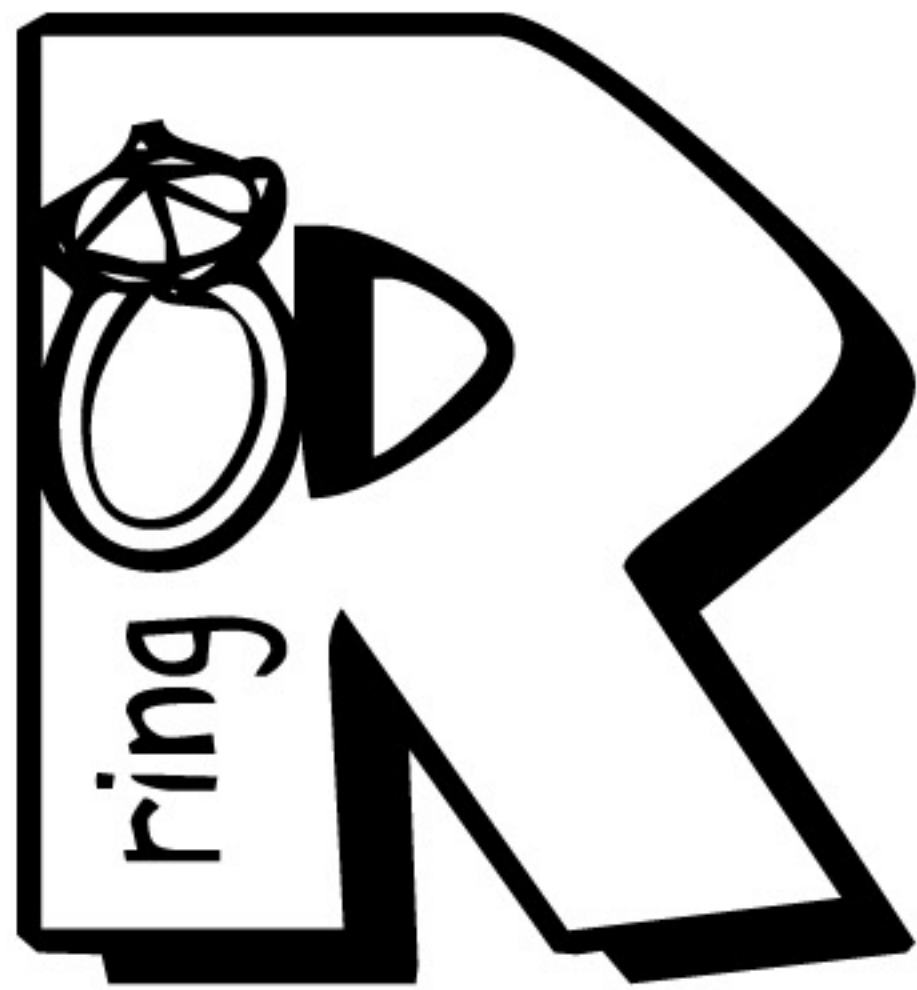

Circle R and r.

R p Q r P q r p Q R  
P s r p Q R S s r p  
r q S R s P q r R s  
S R p q r s p S q r



Trace "r". Read the words.

rat

ret

rim

rod



Trace and write. Follow the numbered arrows.

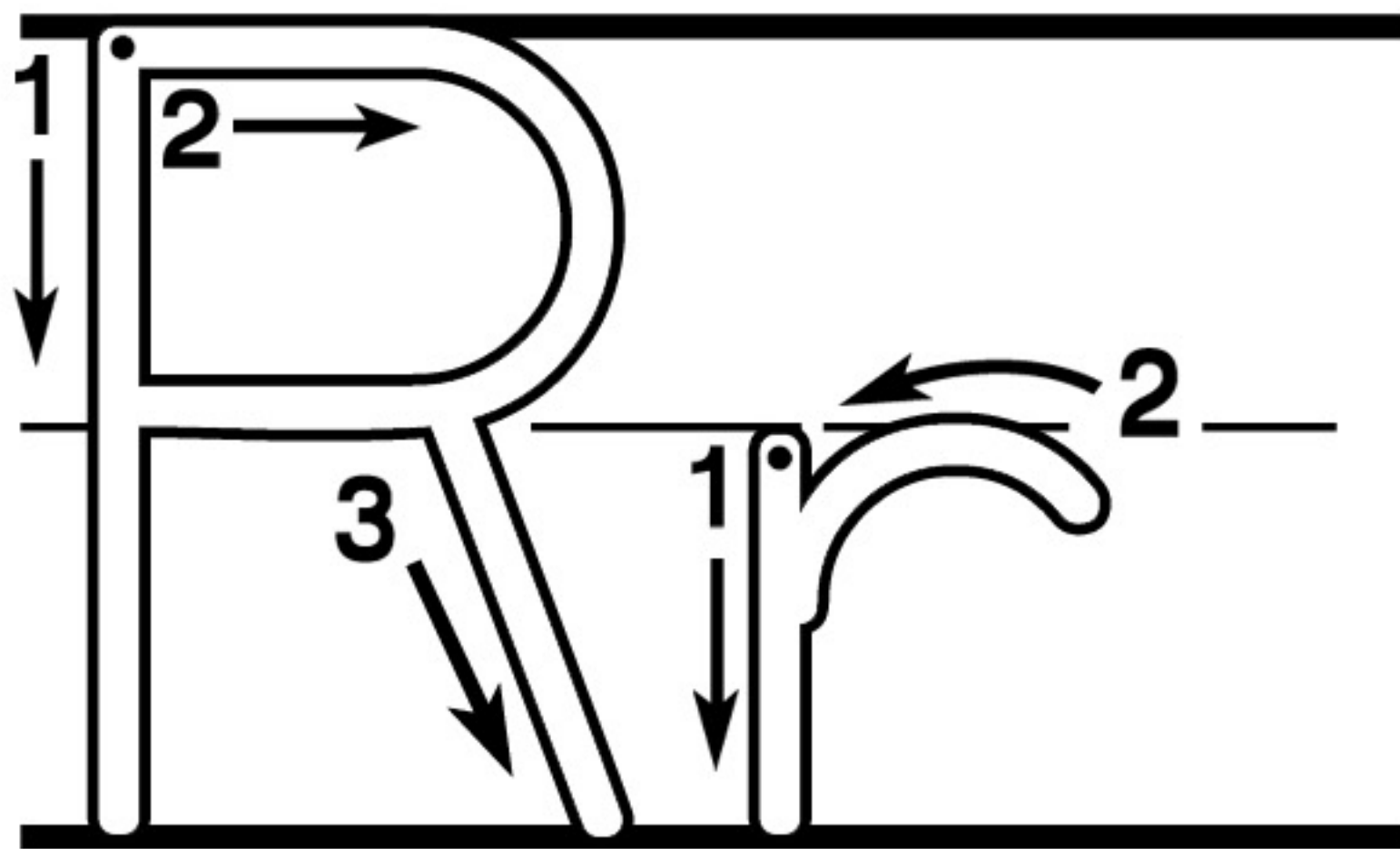

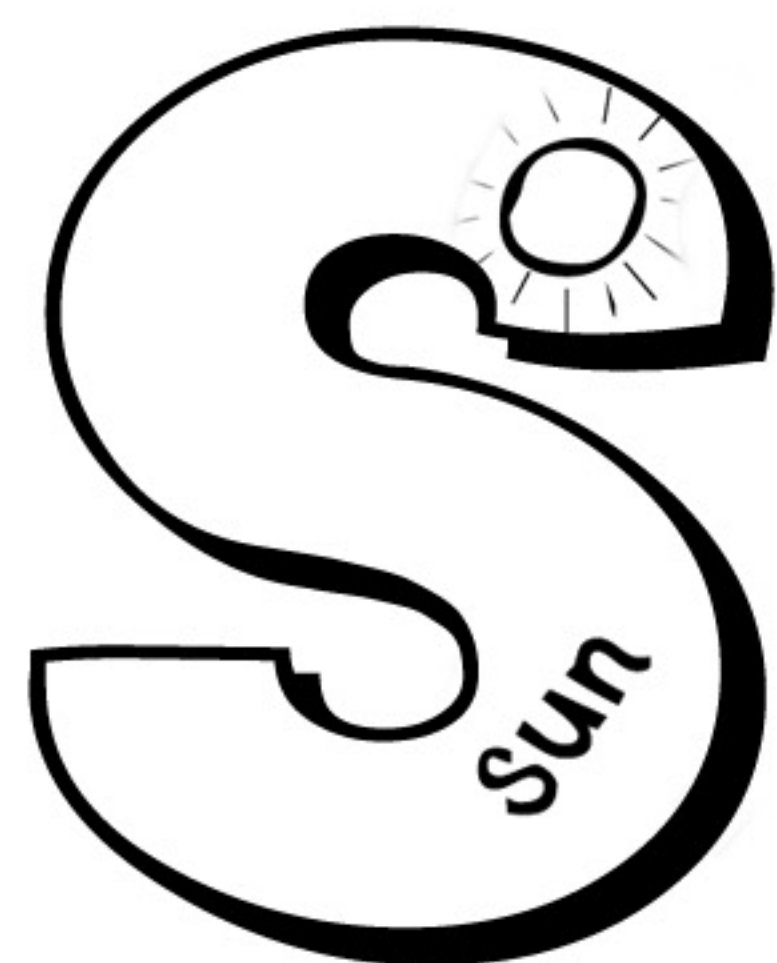

Name \_\_\_\_\_

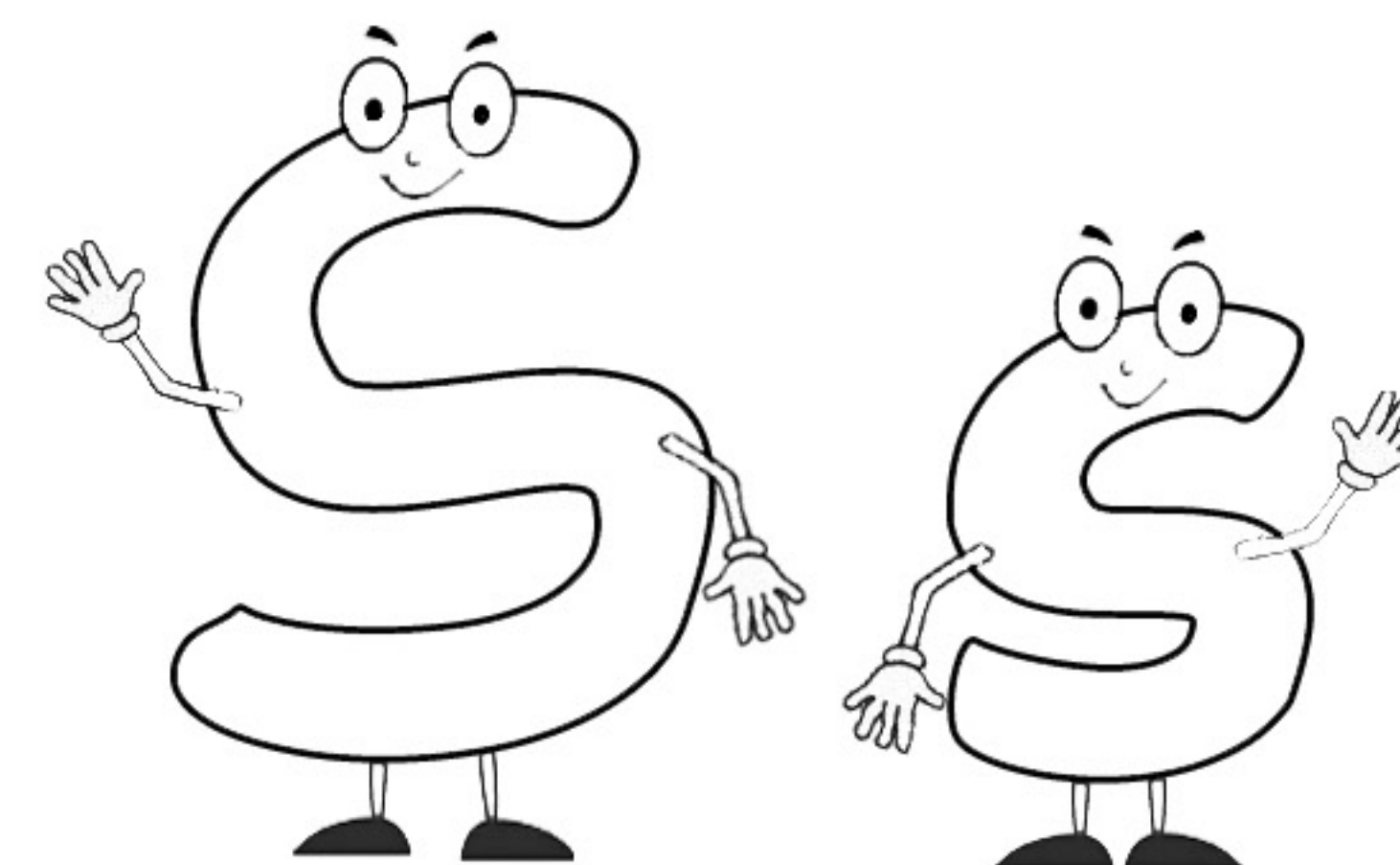
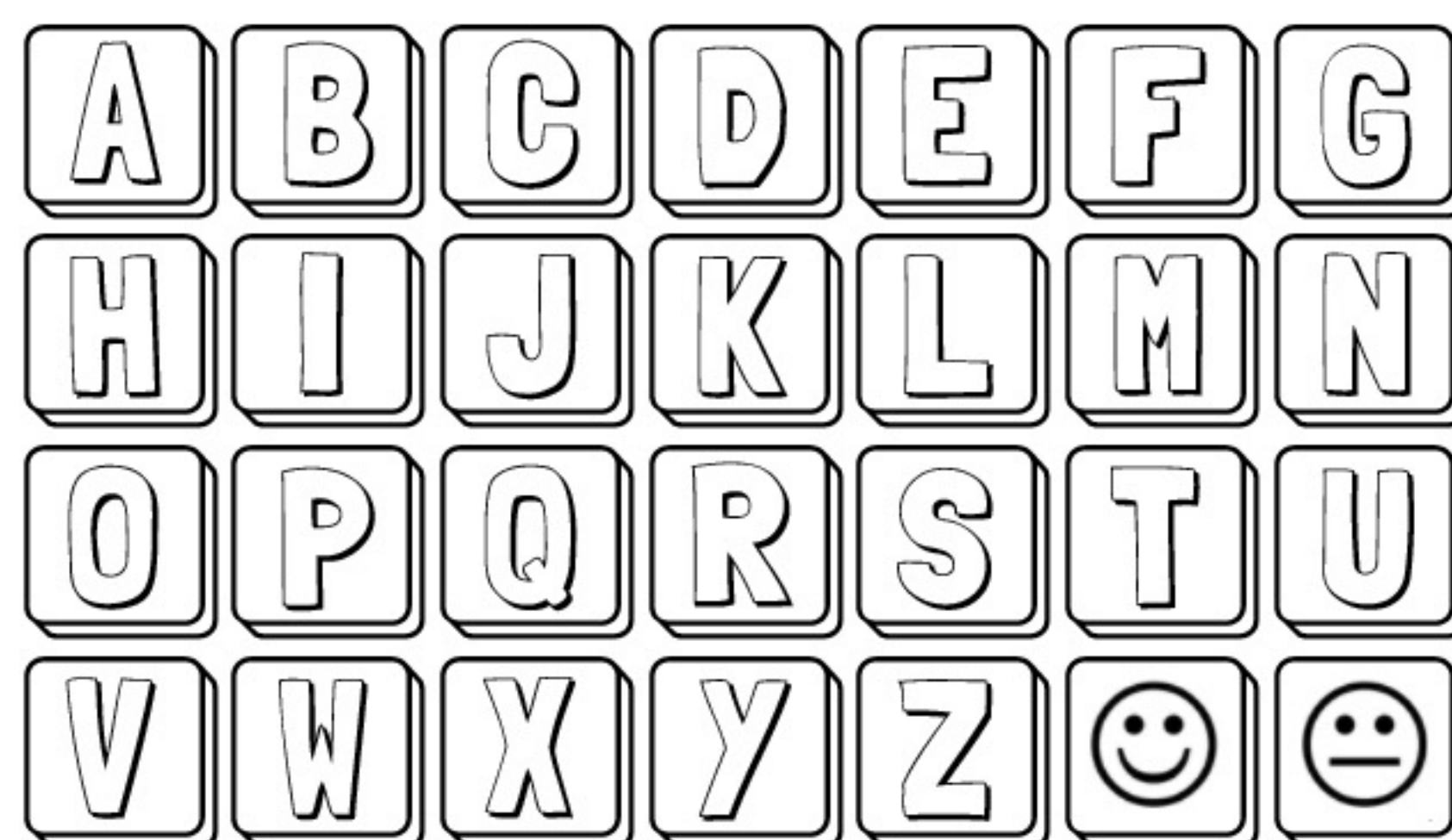

Circle S and s.

S + U s T u s + U S  
T v s + U S V v s +  
s u V S v T u s S v  
V S + u s v + V u s

Trace "s". read the words.

sob                      sot  
sat                        son

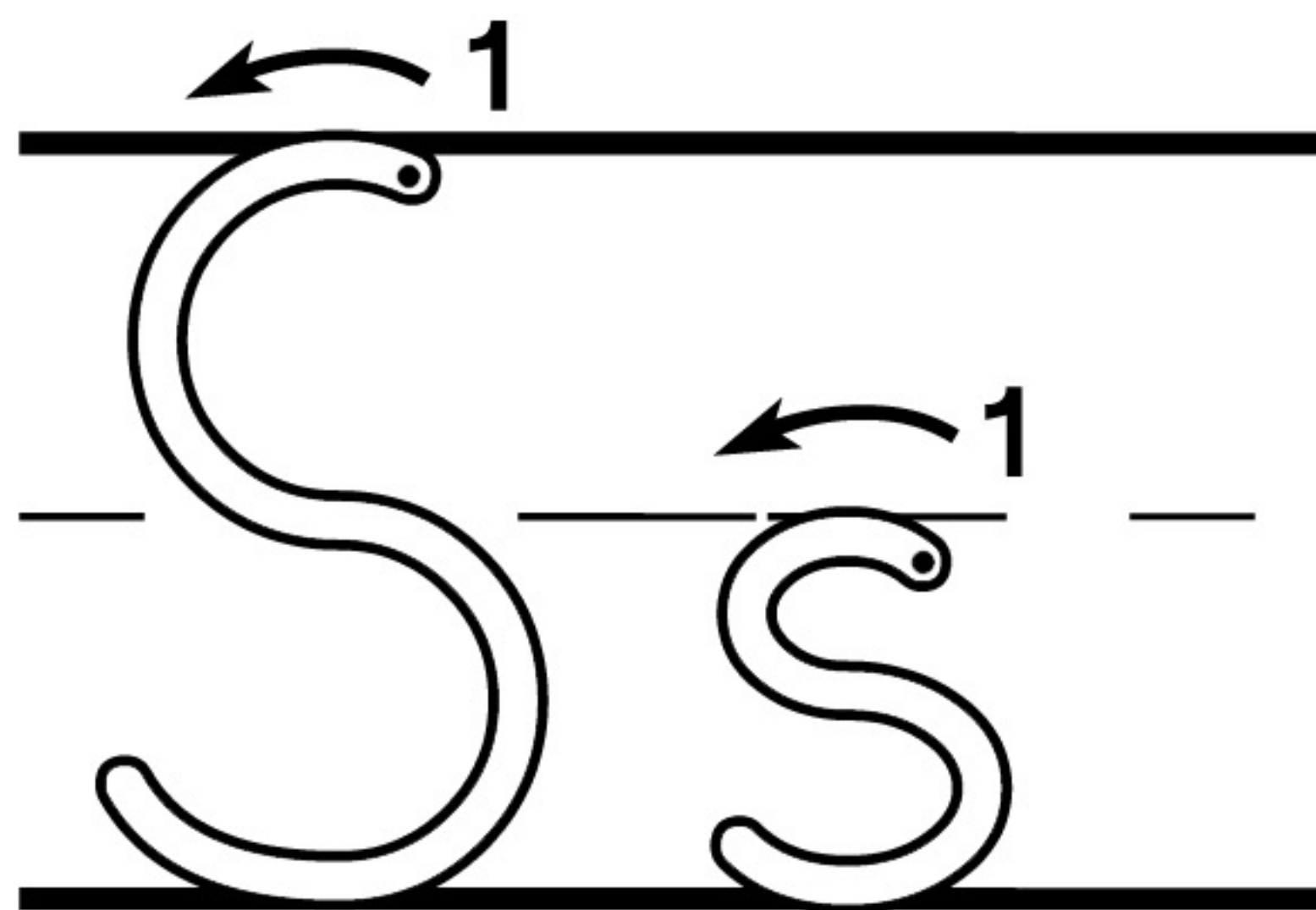

Trace and write. Follow the numbered arrows.

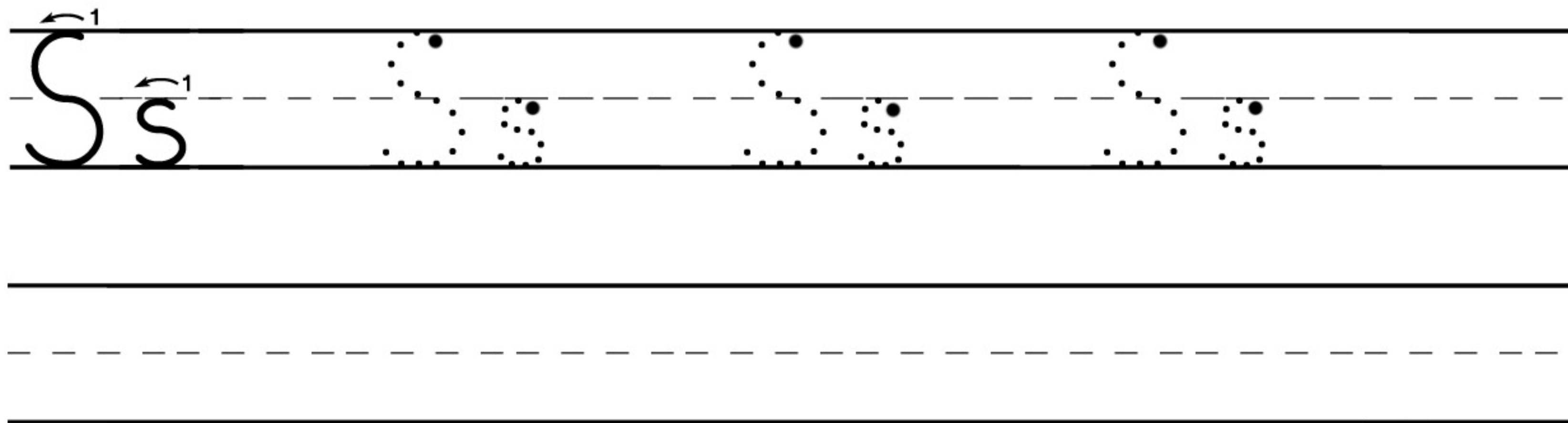



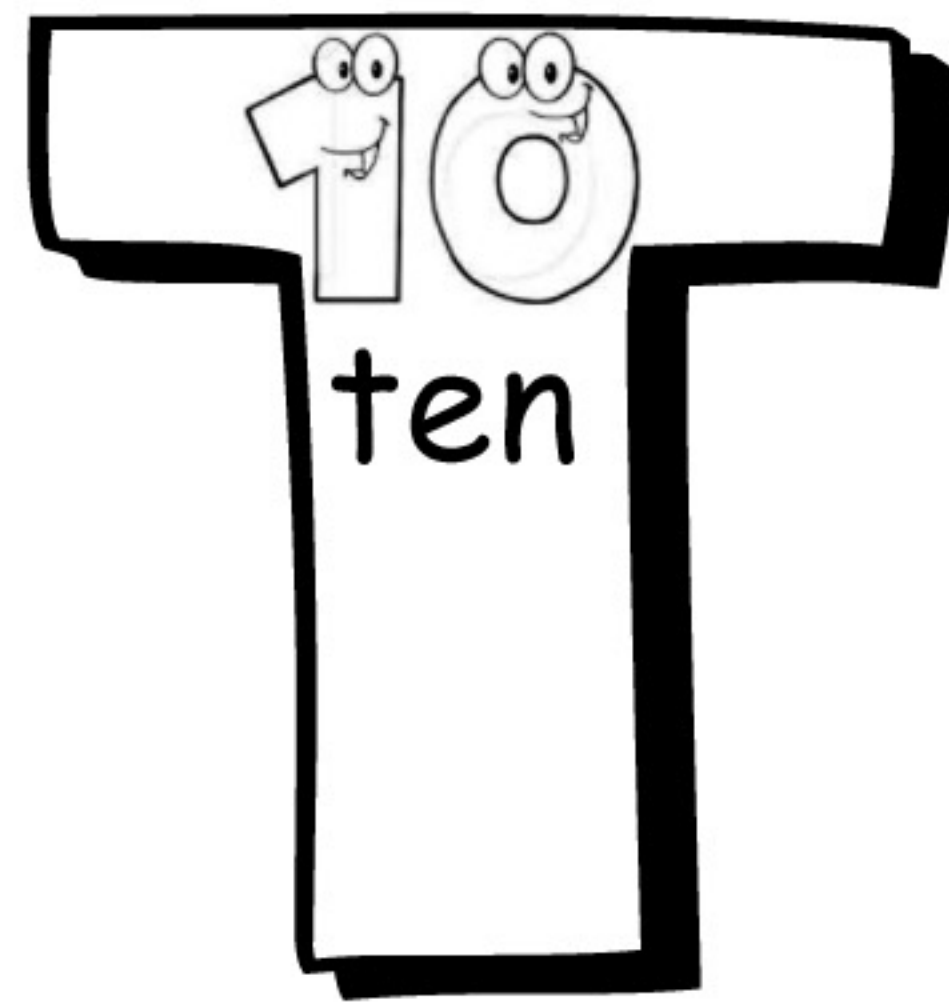

Name \_\_\_\_\_

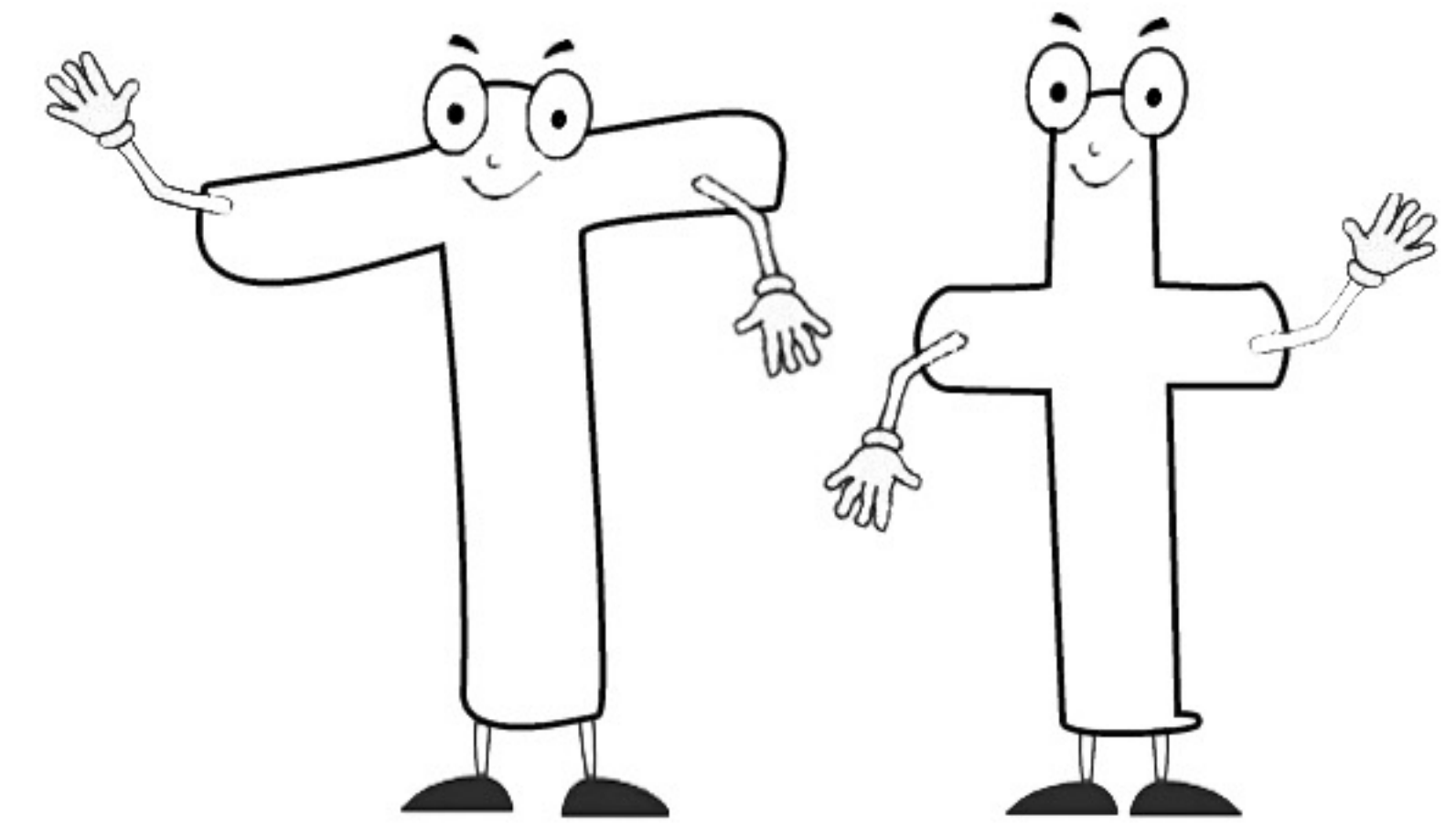
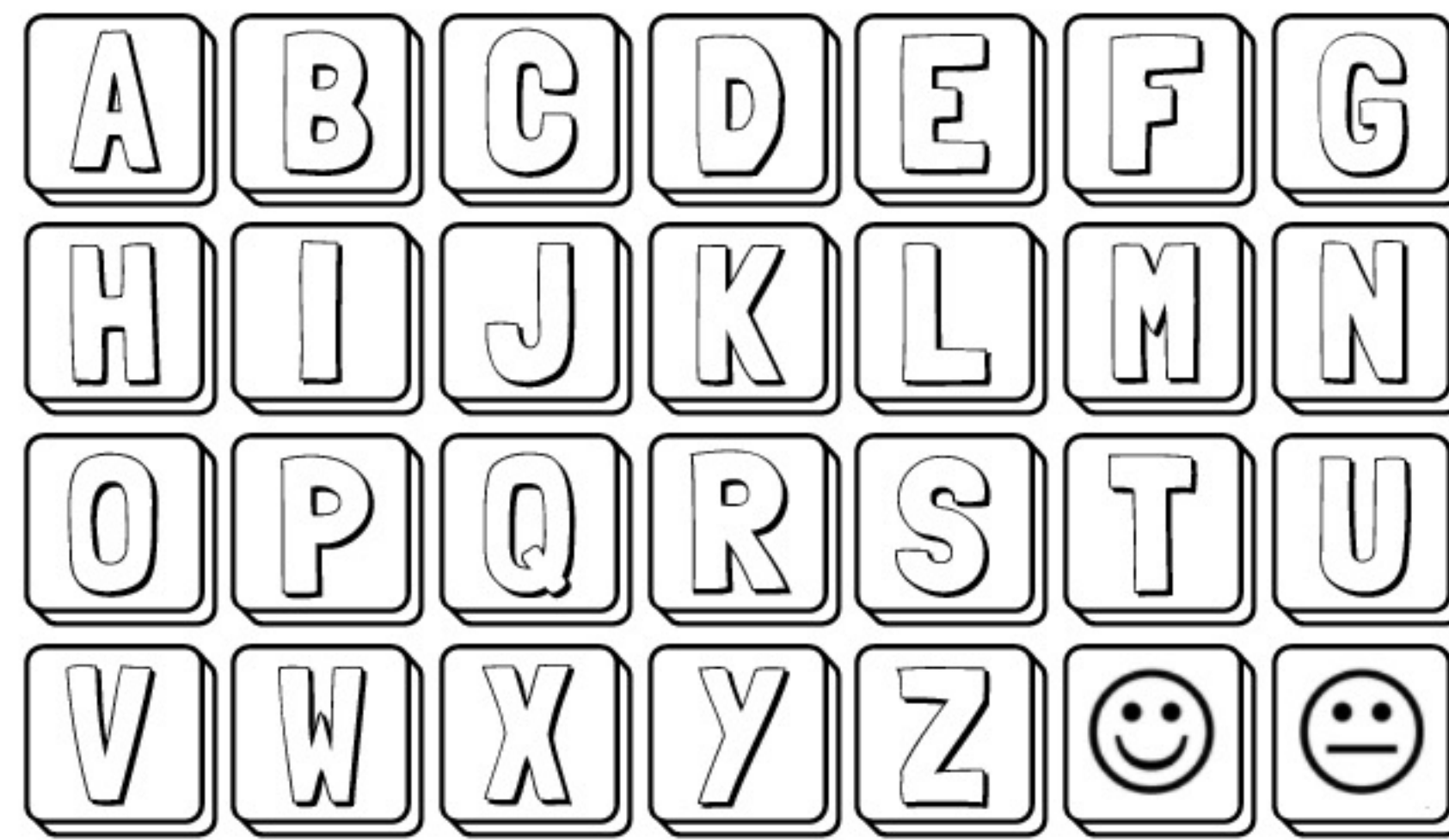

 Circle T and t.

T u S t U s t u S T  
U v t u S T V v t u  
t s V T v U s t T v  
V T u s t v u V s t

 Trace "t". Read the words

t og t ag  
t op t ap

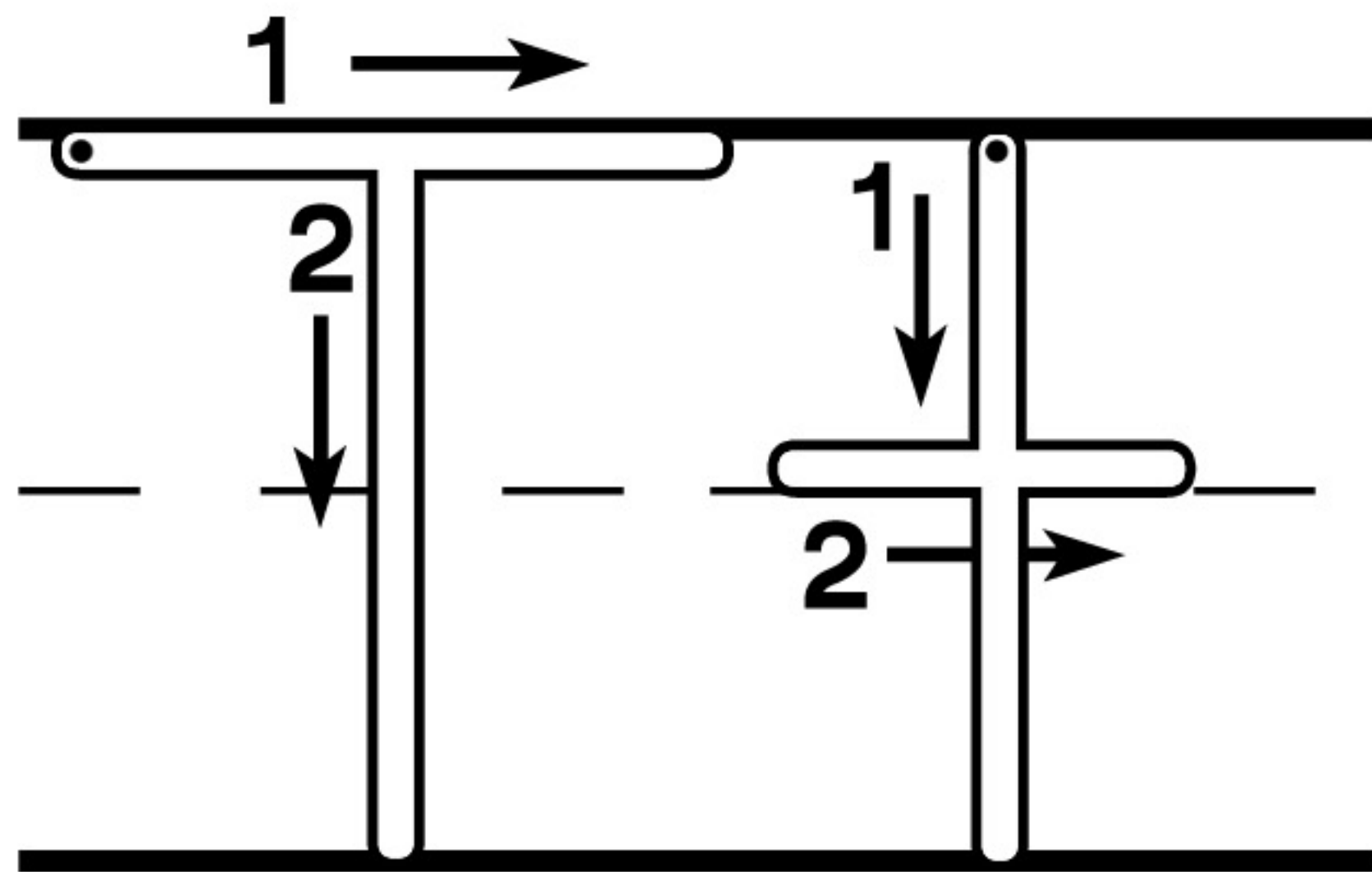

 Trace and write. Follow the numbered arrows.

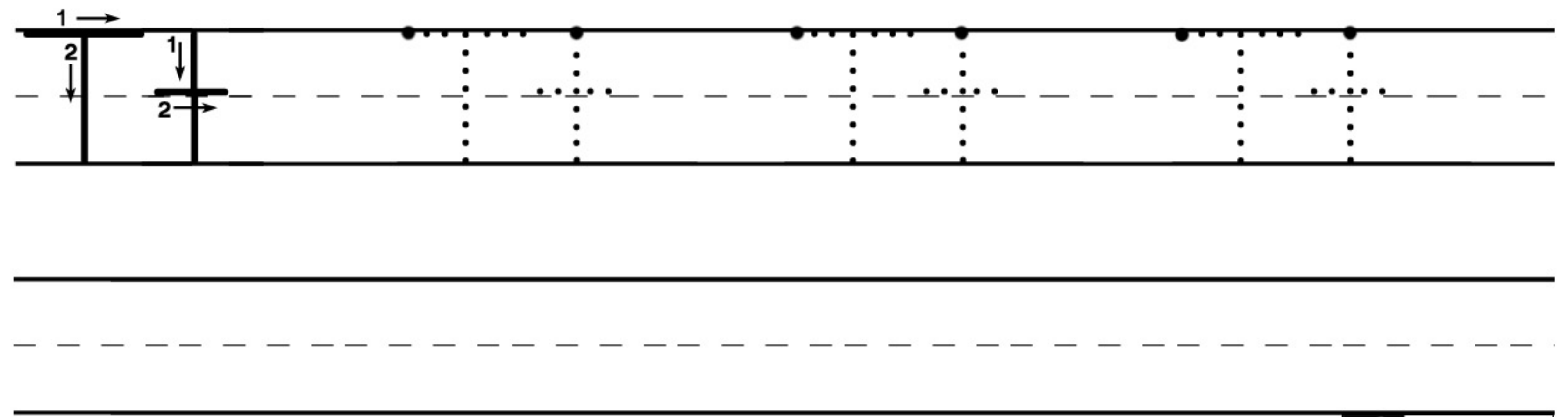

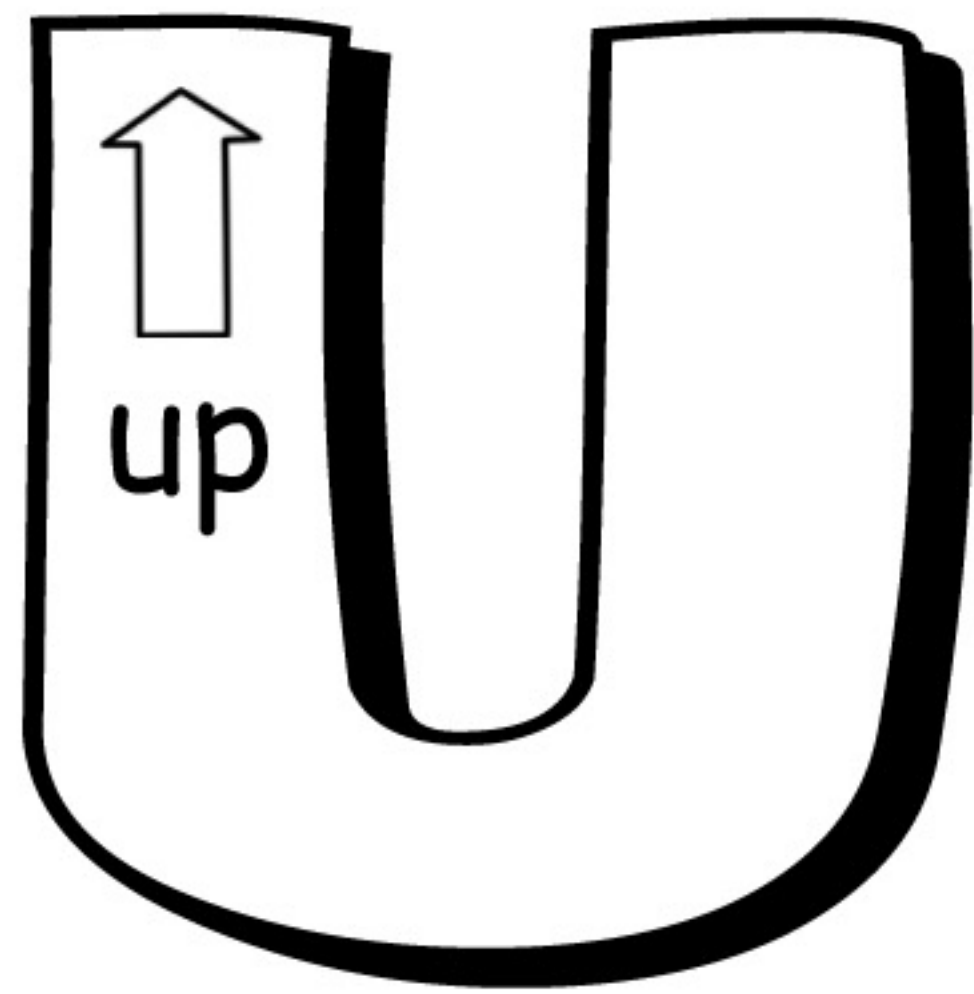

Name \_\_\_\_\_

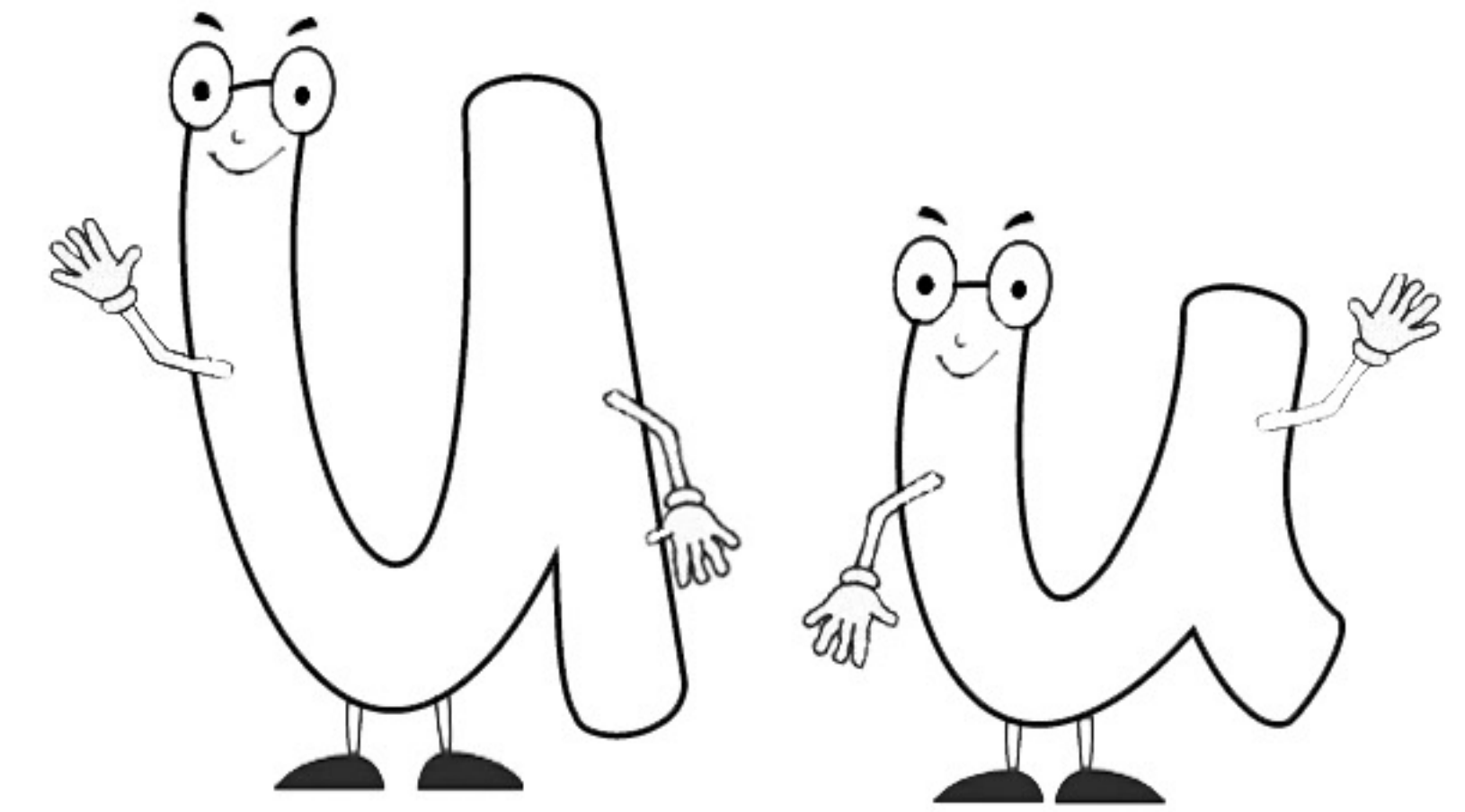
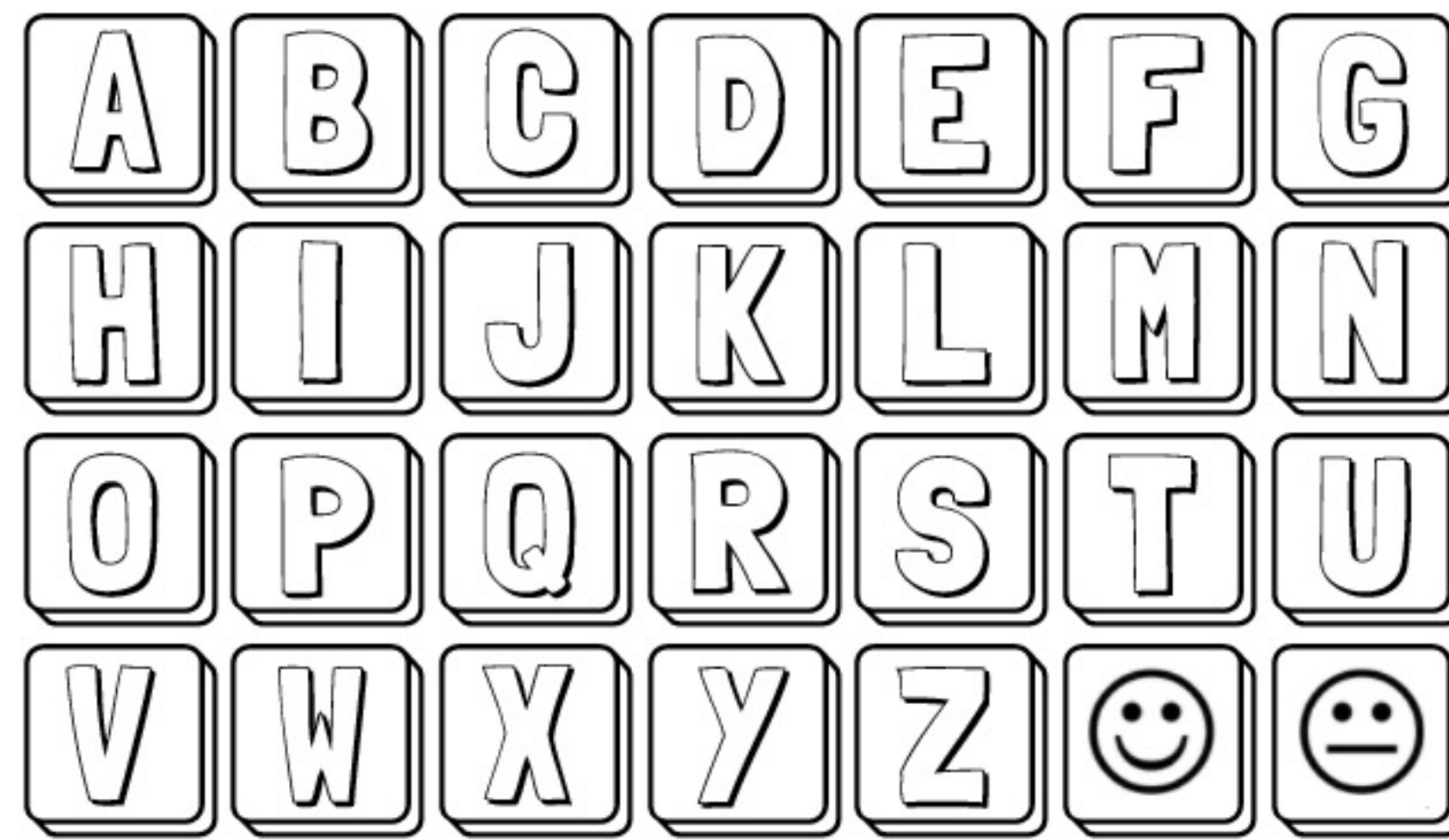

 Circle U and u.

U + S u T s u + S U  
T v u + S U V v u +  
u s V U v T s u U v  
V U + s u v + V s u



Trace "u". read the words.

up

cut

fun

sun

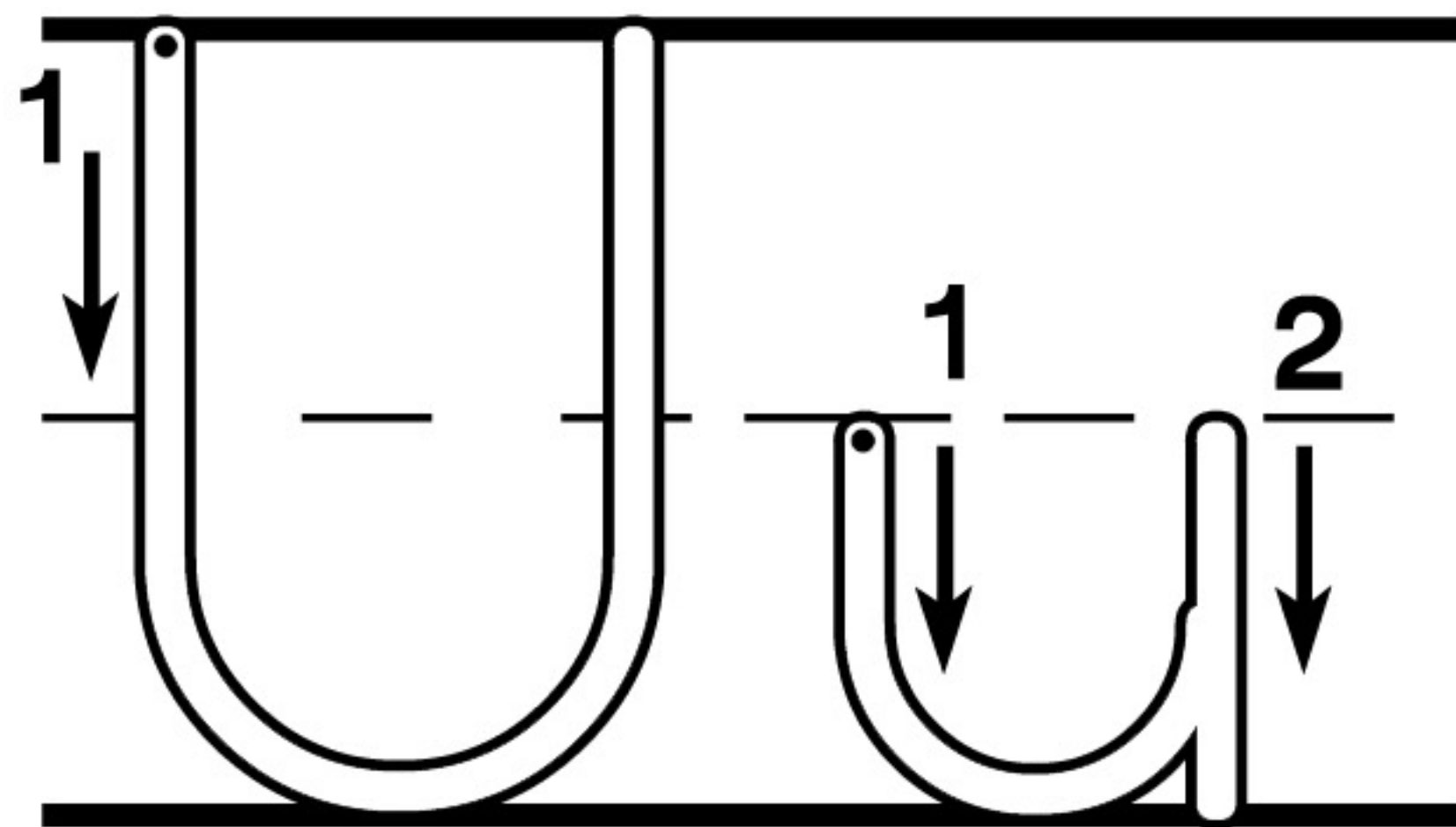

 Trace and write. Follow the numbered arrows.

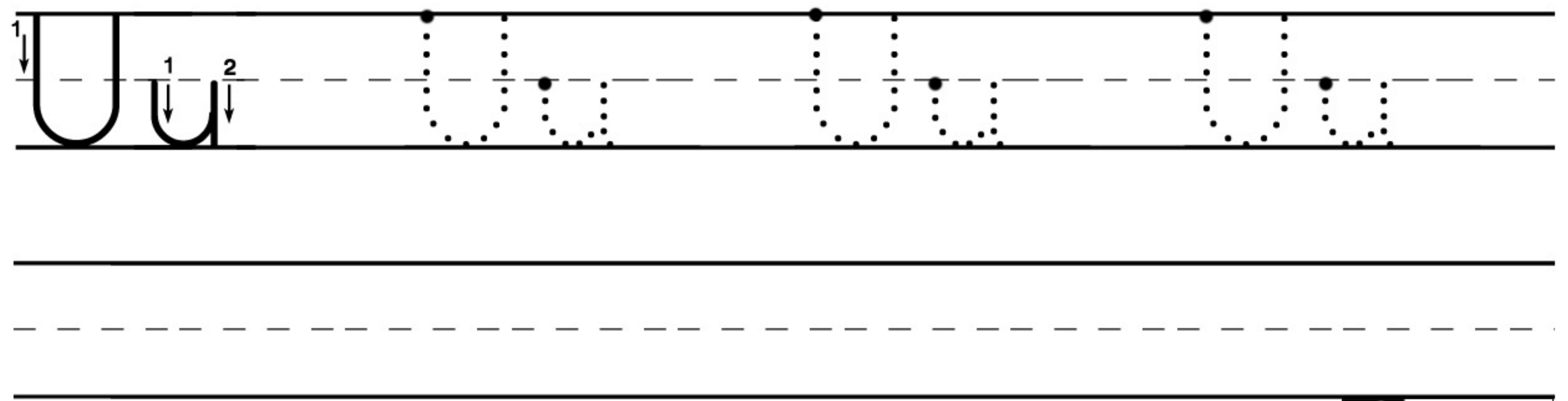

Name \_\_\_\_\_

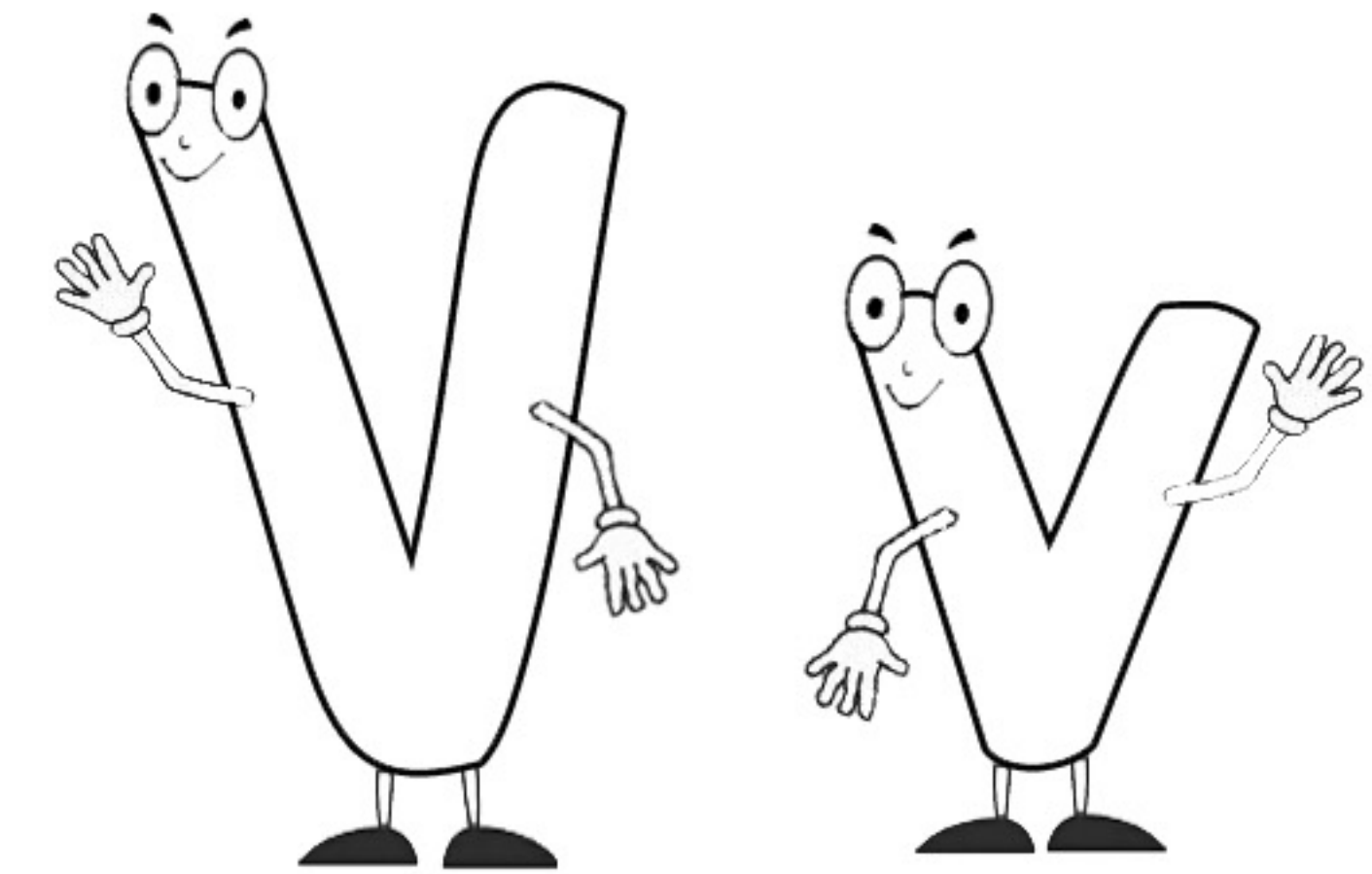
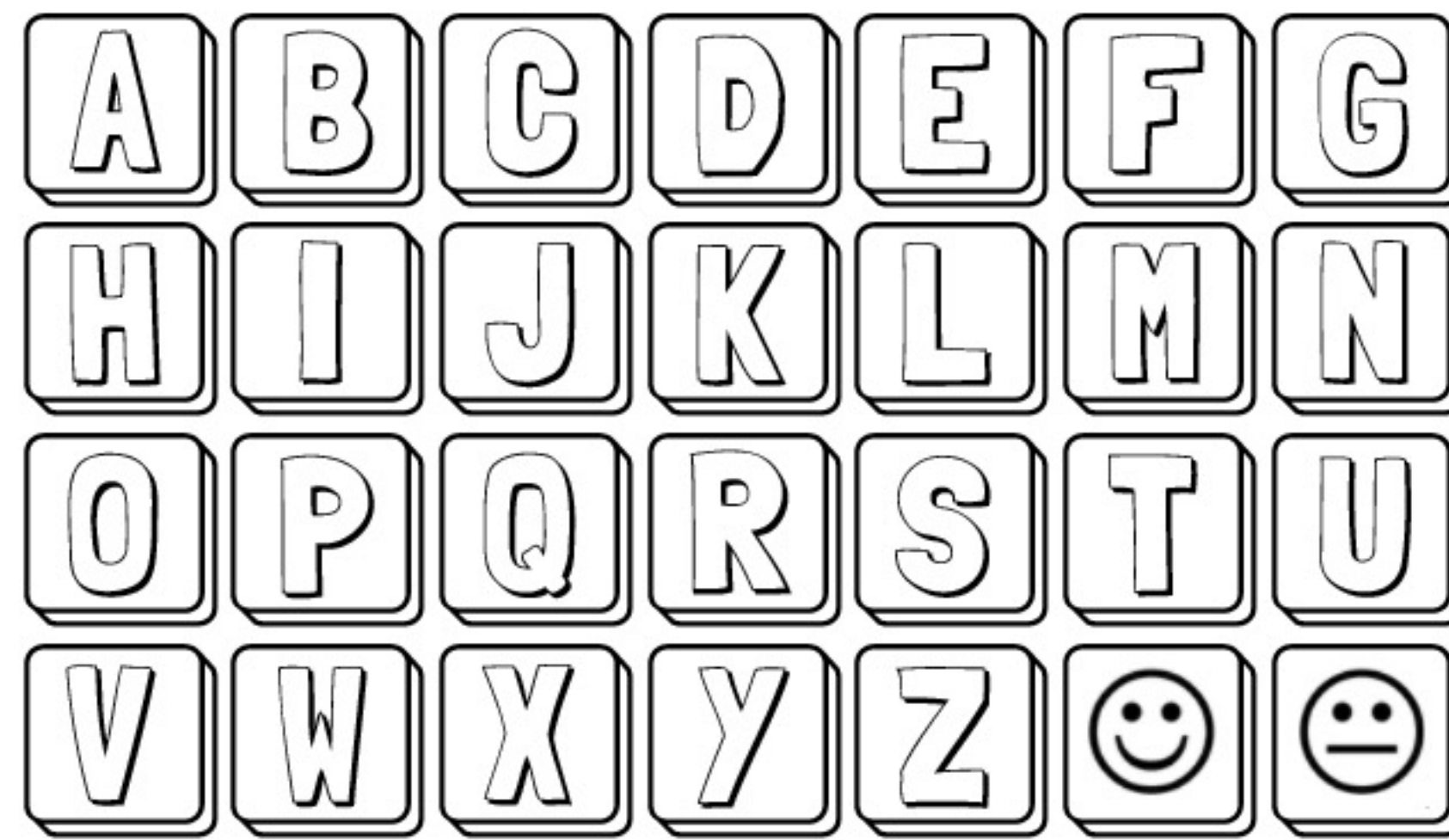
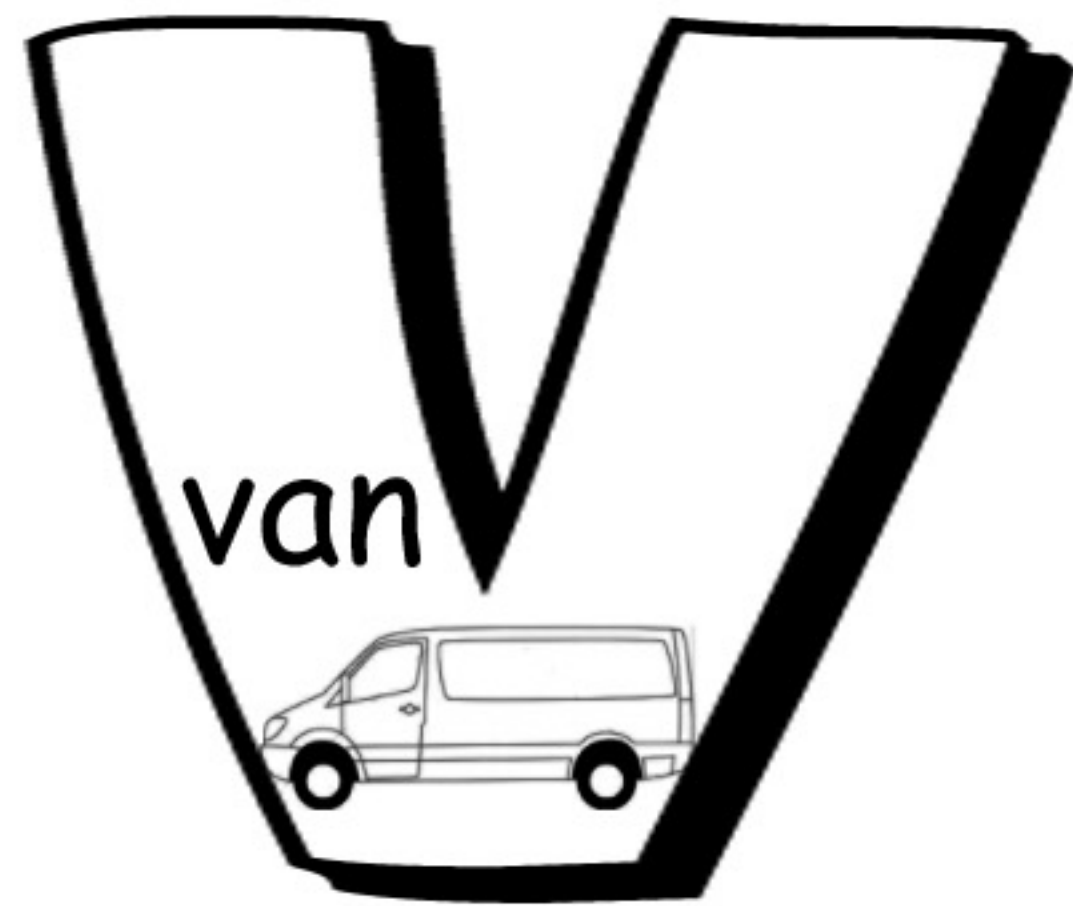

Circle v and v.

V y W v Y w v y W V  
Y x v y W V X x v y  
v w X V x Y w v V x  
X V y w v x y X w v

Trace "v". read the words.

vat van  
vet vim

Trace and write. Follow the numbered arrows.

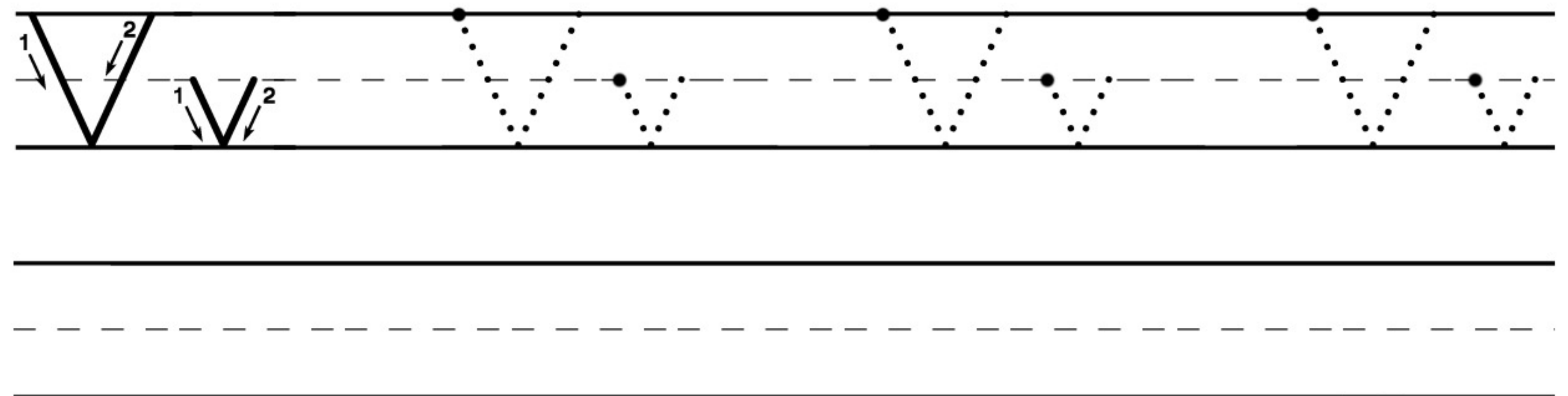
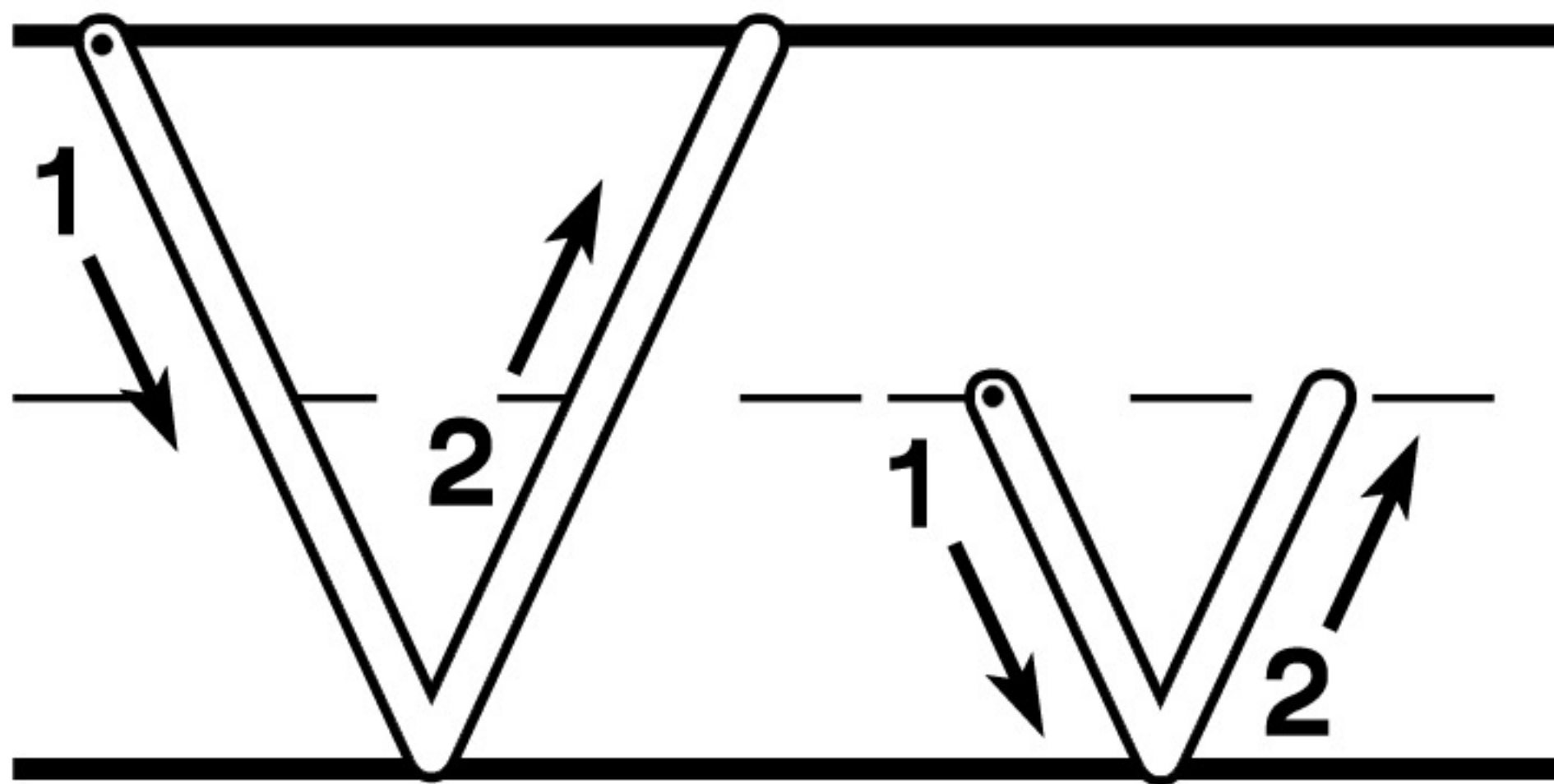



Name \_\_\_\_\_

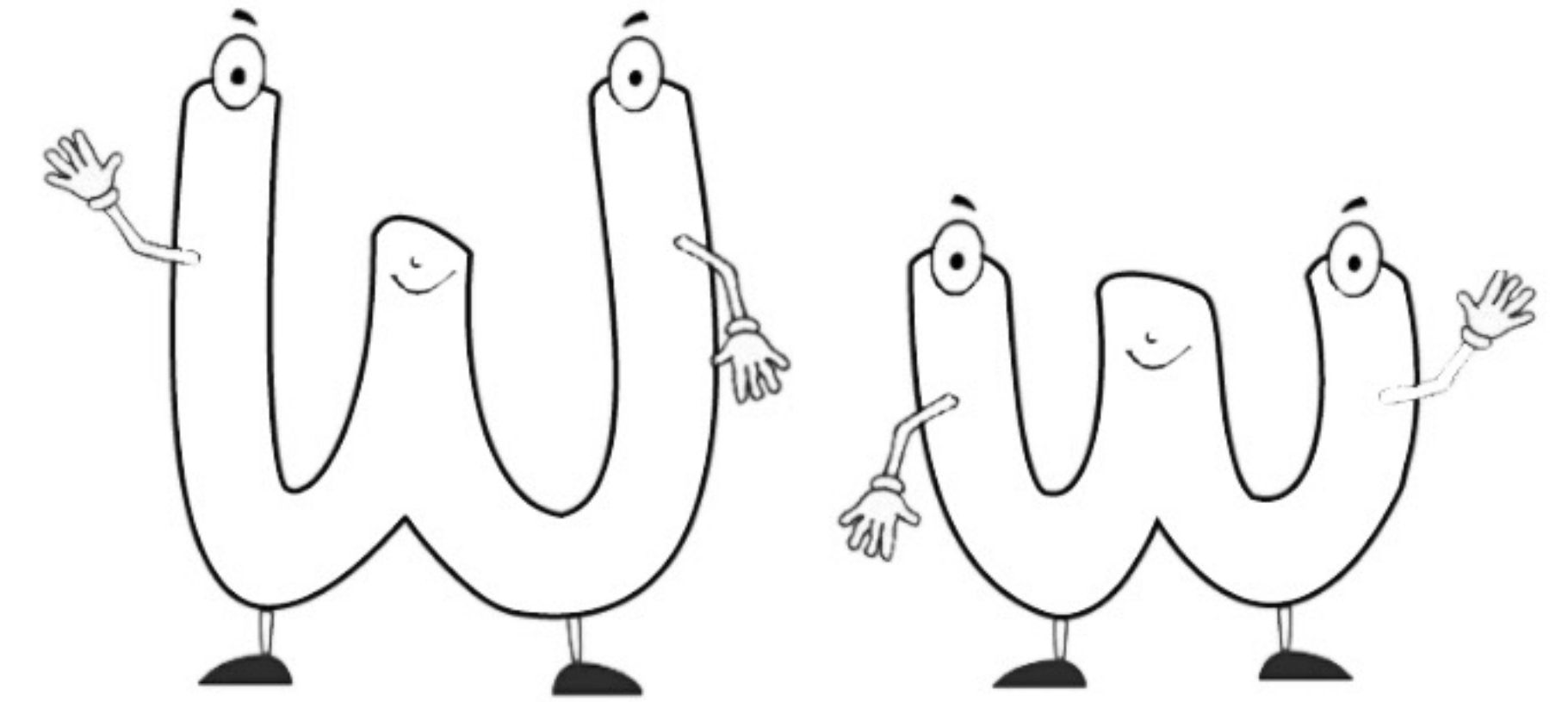
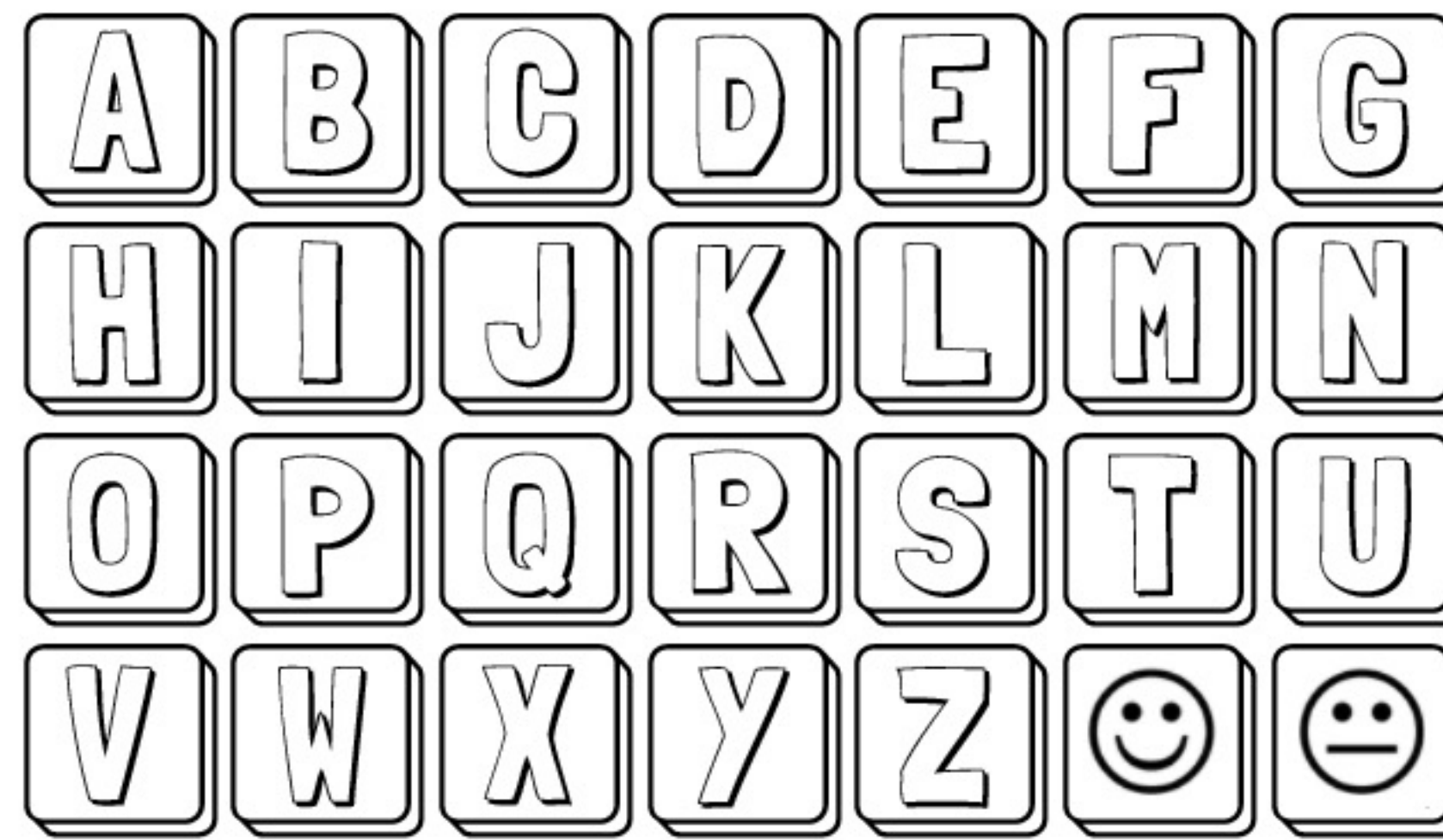

Circle W and w.

W z Y w Z y w z Y W  
Z x w z Y W X x w z  
w y X W x Z y w W x  
X W z y w x z X y w

Trace "w". Read the words

was wet  
win wed

Trace and write. Follow the numbered arrows.

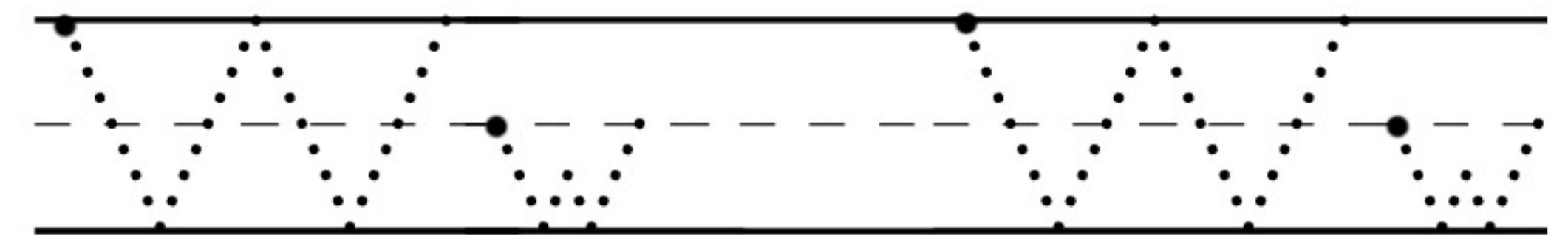
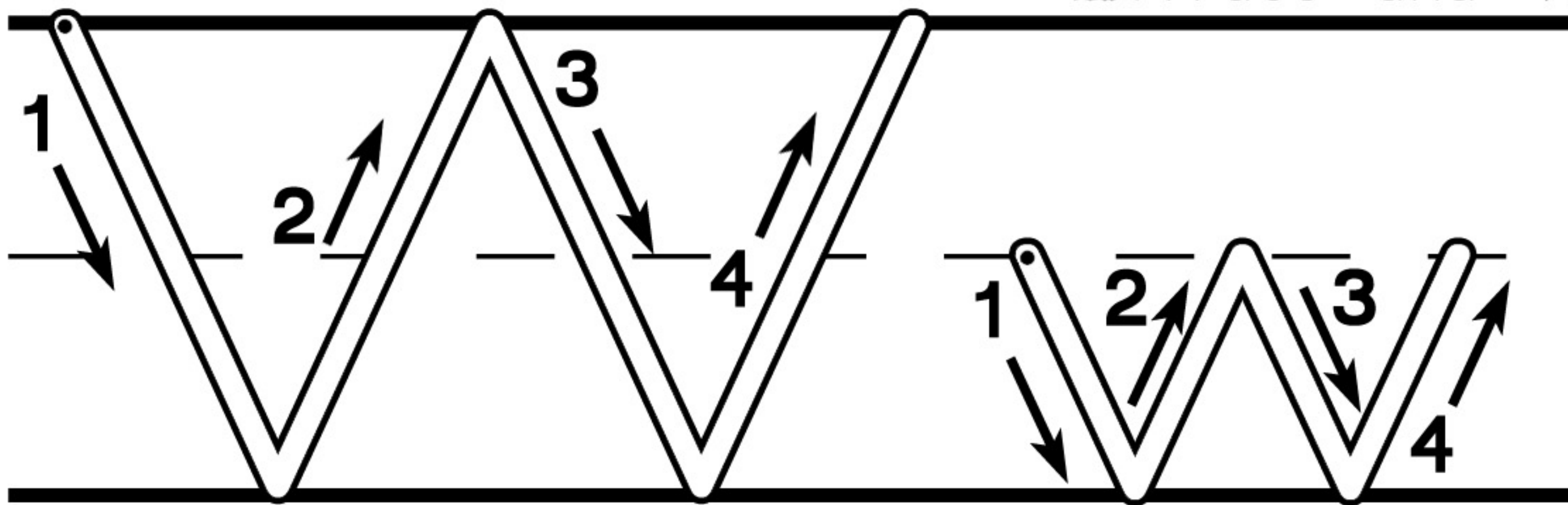

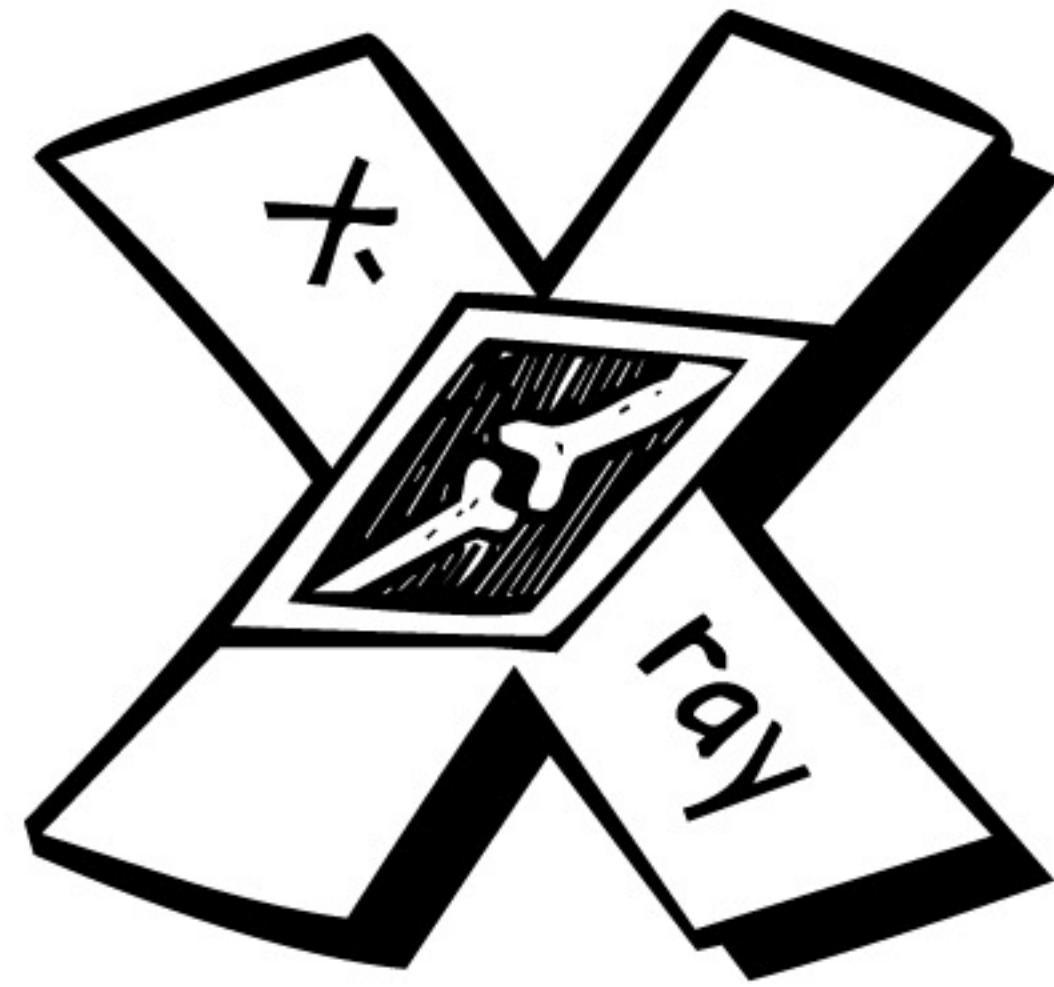

Name \_\_\_\_\_

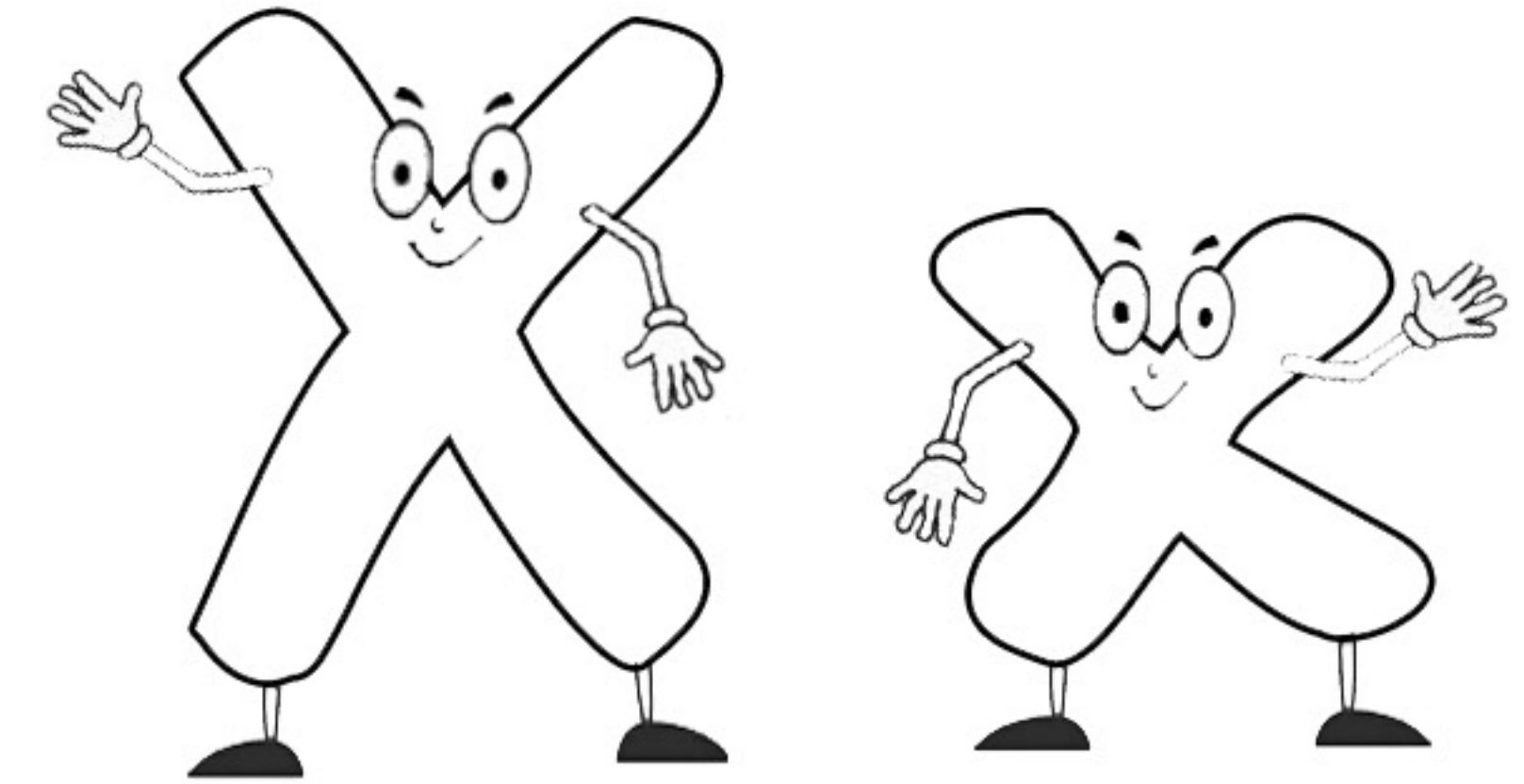
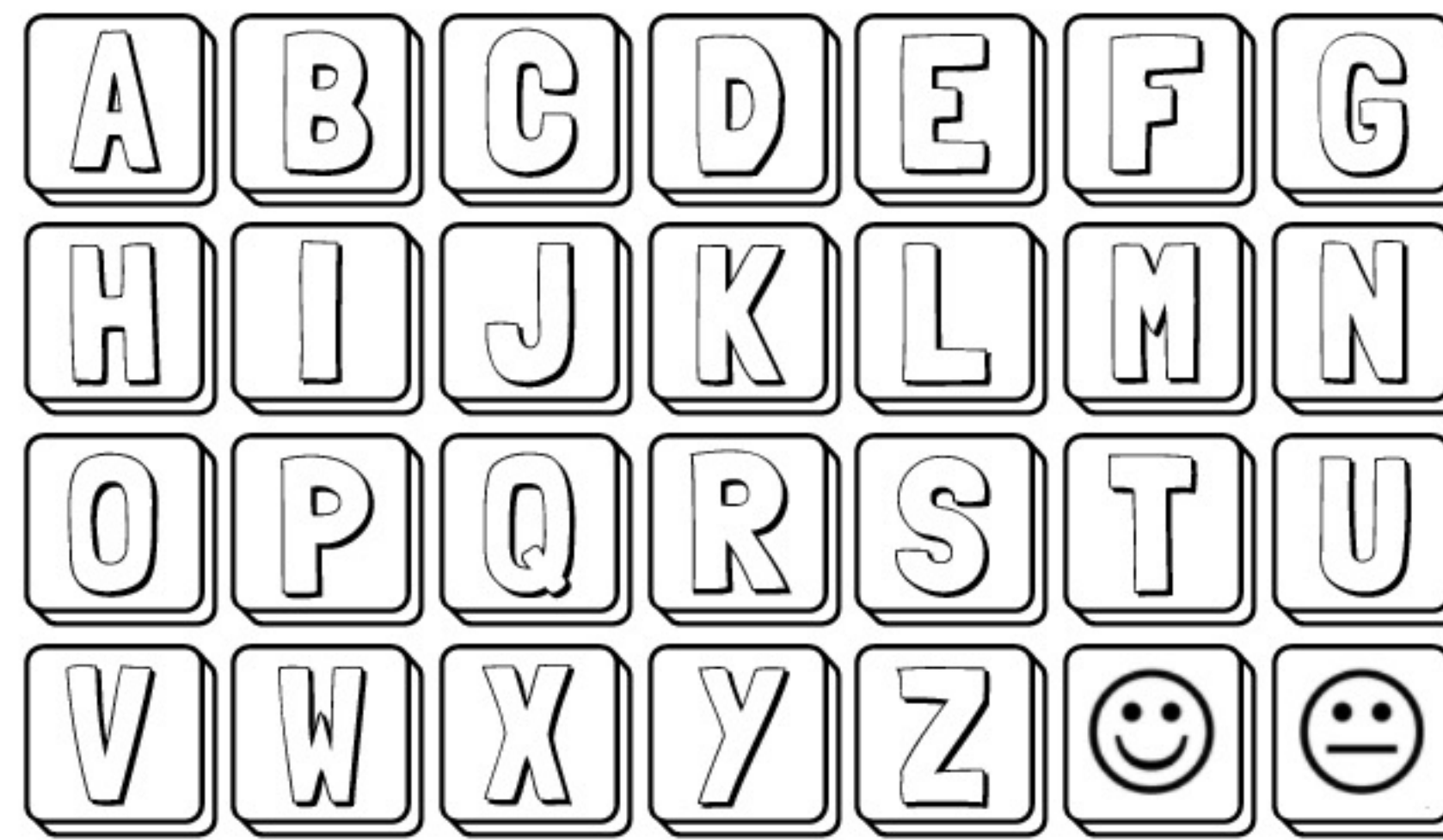

Circle X and x.

X	w	Y	x	W	y	x	w	Y	X
W	z	x	w	Y	X	Z	z	x	w
x	y	Z	X	z	W	y	x	X	z
Z	X	w	y	x	z	w	Z	y	x

Trace "x". read the words.

fax

vex

fix

fox

Trace and write. Follow the numbered arrows.

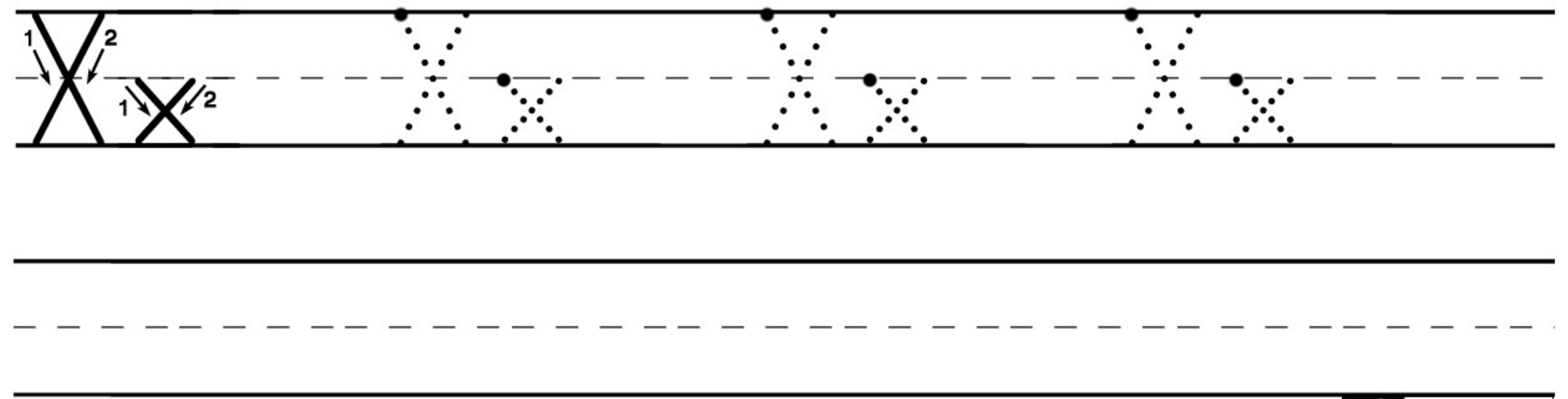
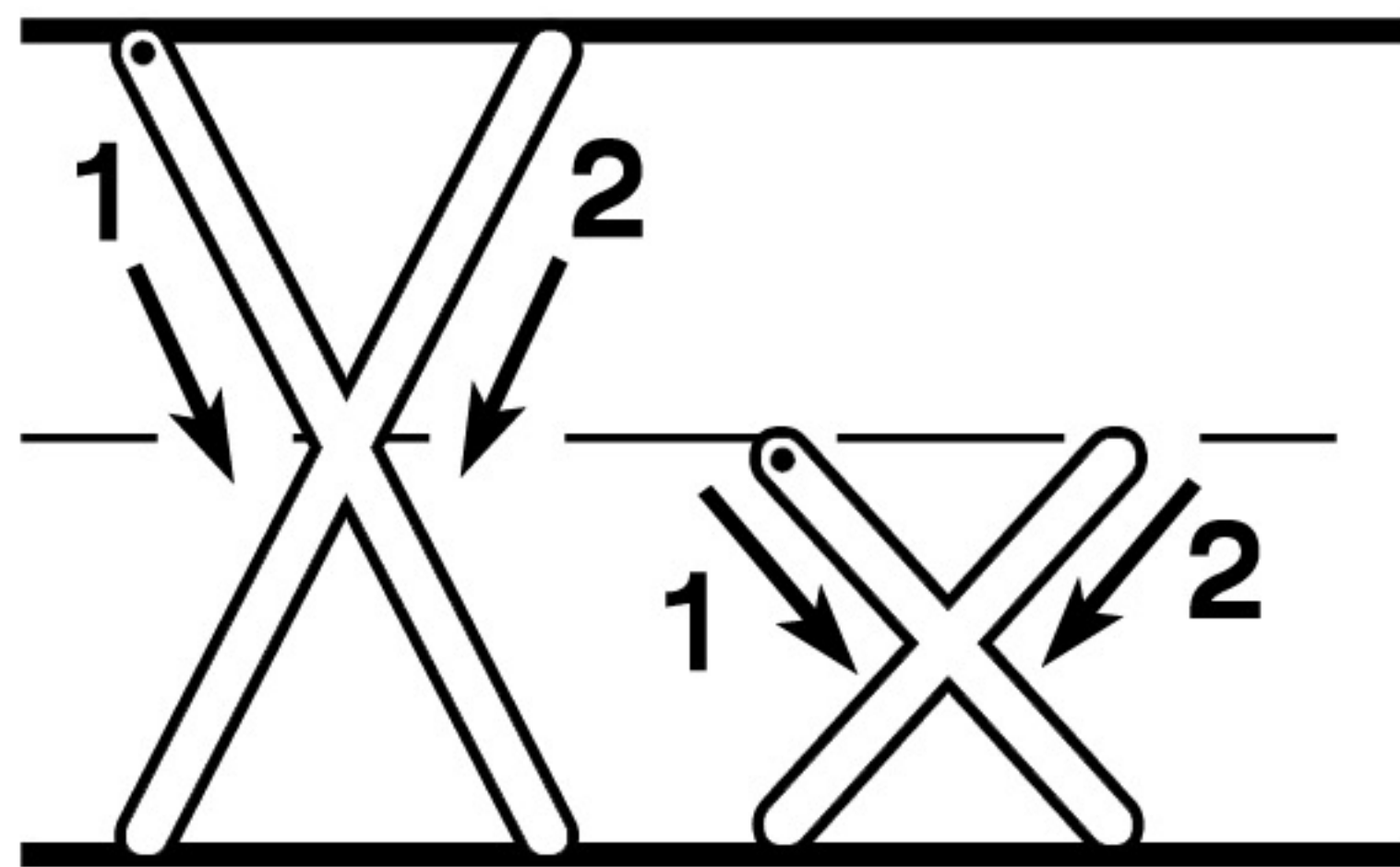

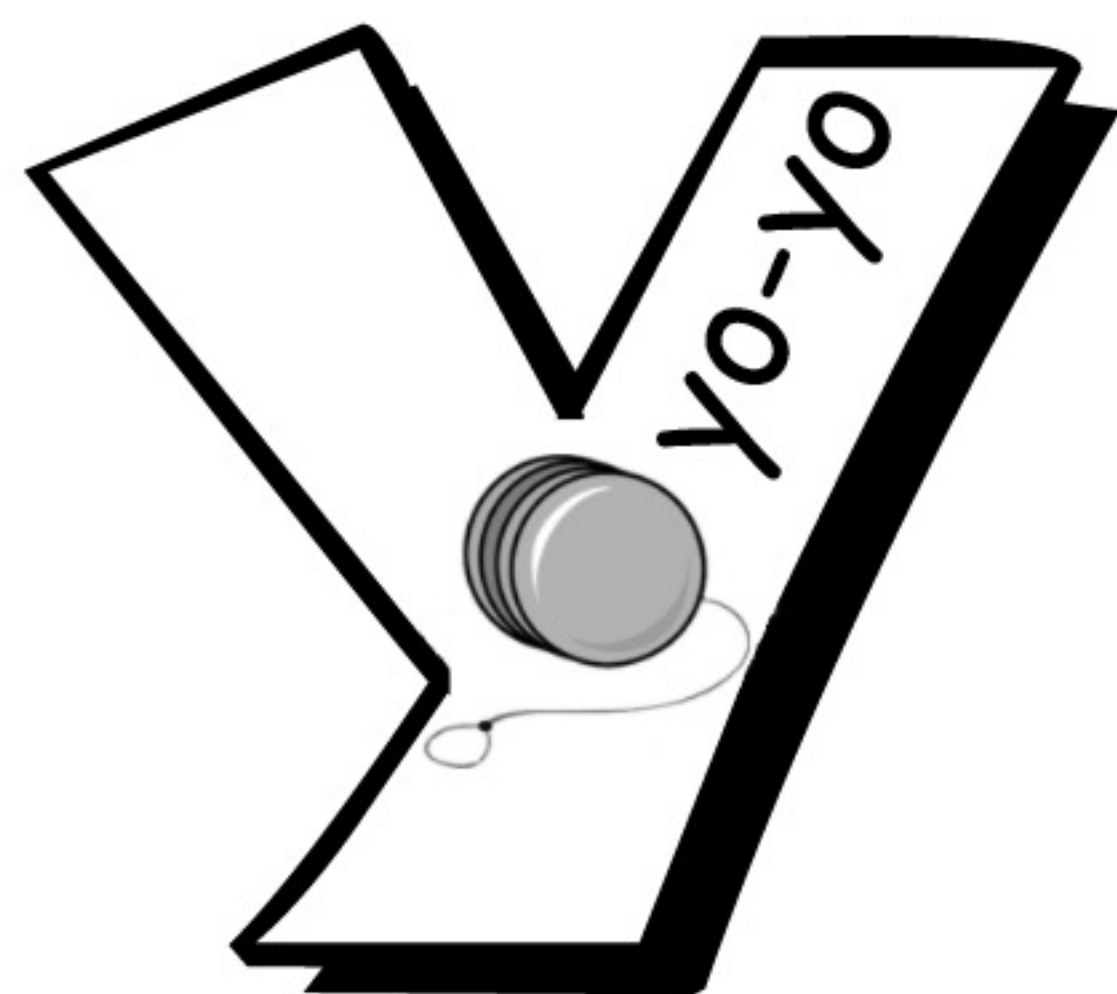

Name \_\_\_\_\_

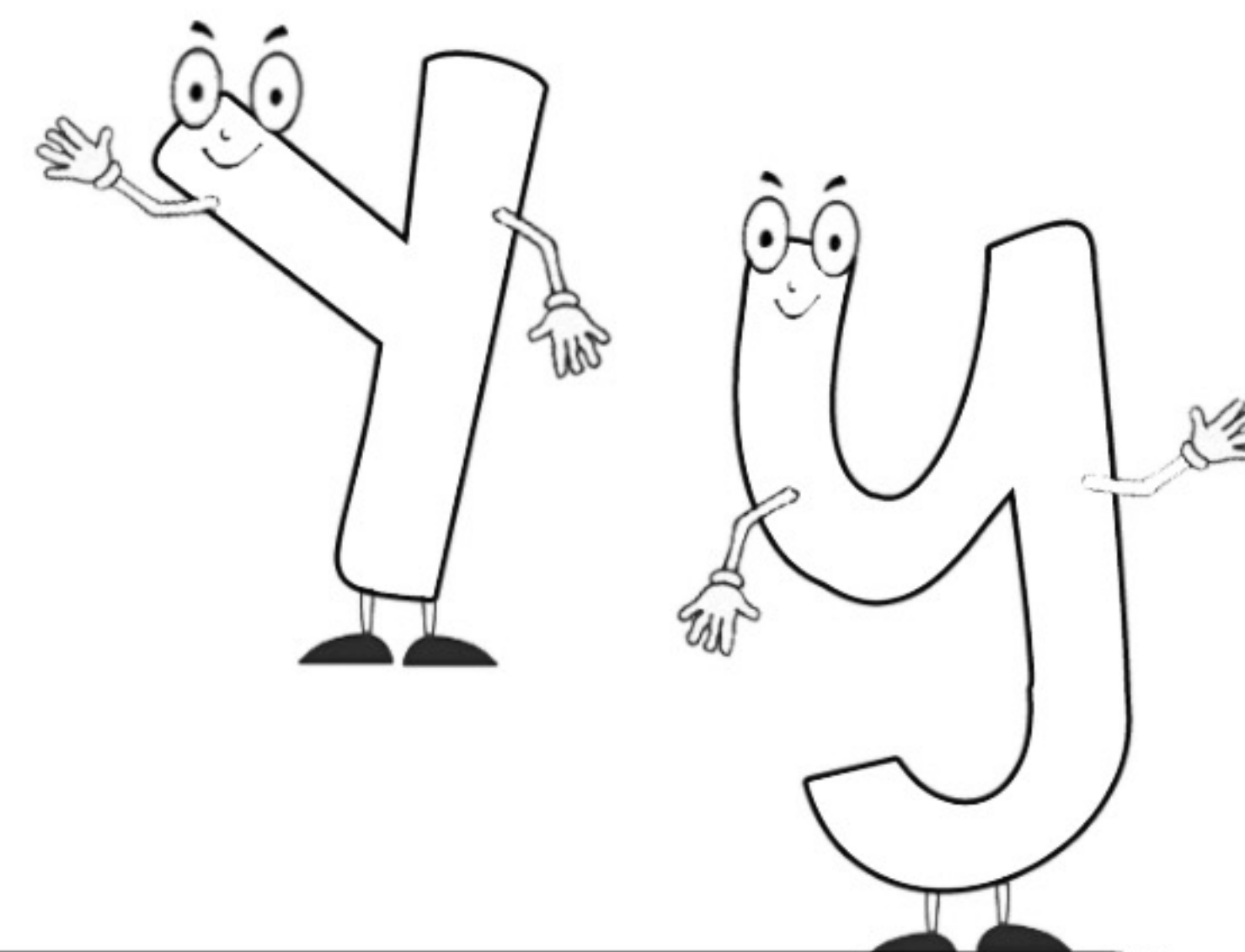
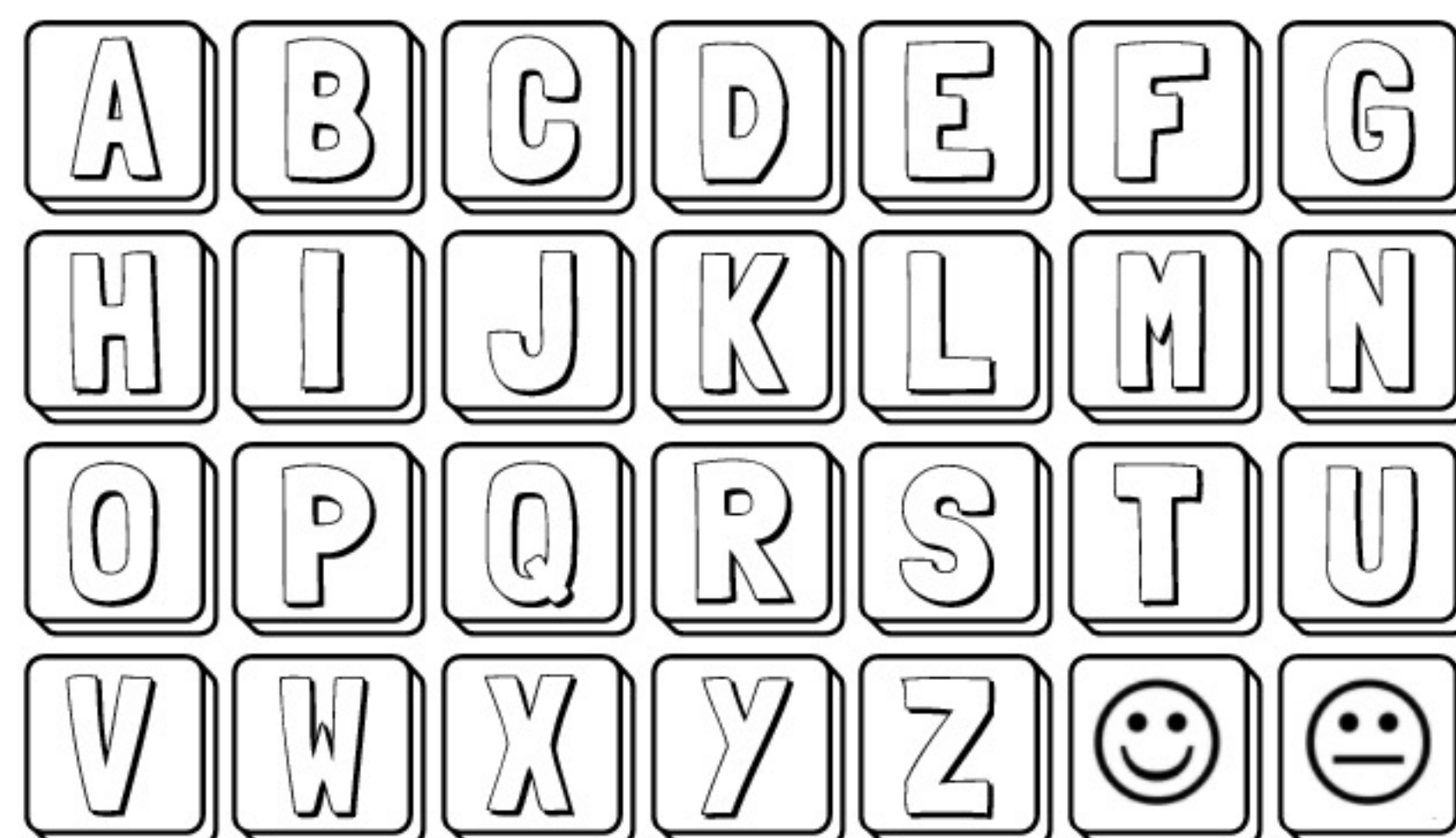

Circle Y and y.

Y w V y W v y w V Y  
W z y w V Y Z z y w  
y v Z Y z W v y Y z  
Z Y w v y z w Z v y

Trace "y". read the words.

yap

yes

yip

yup

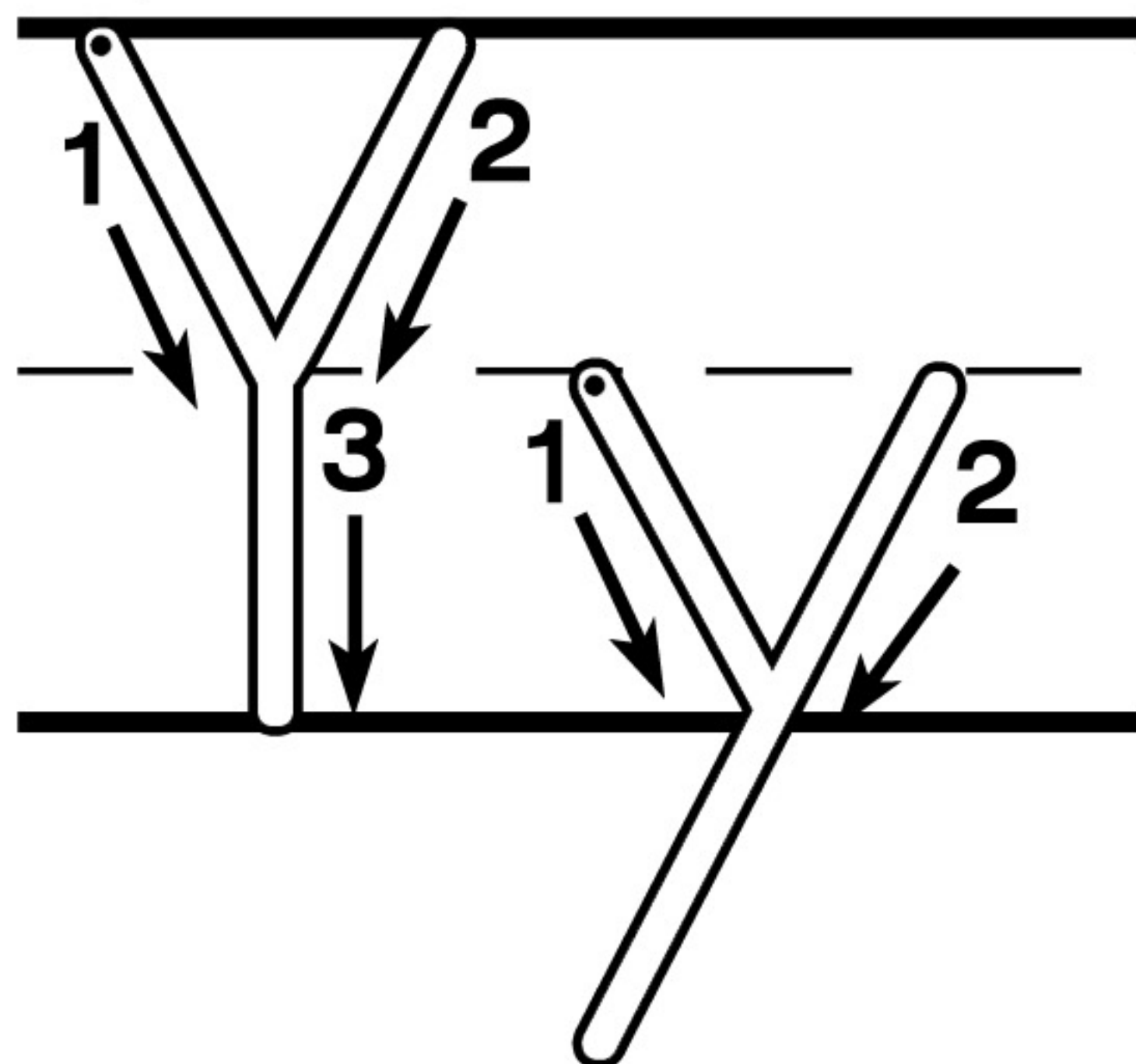

Trace and write. Follow the numbered arrows.

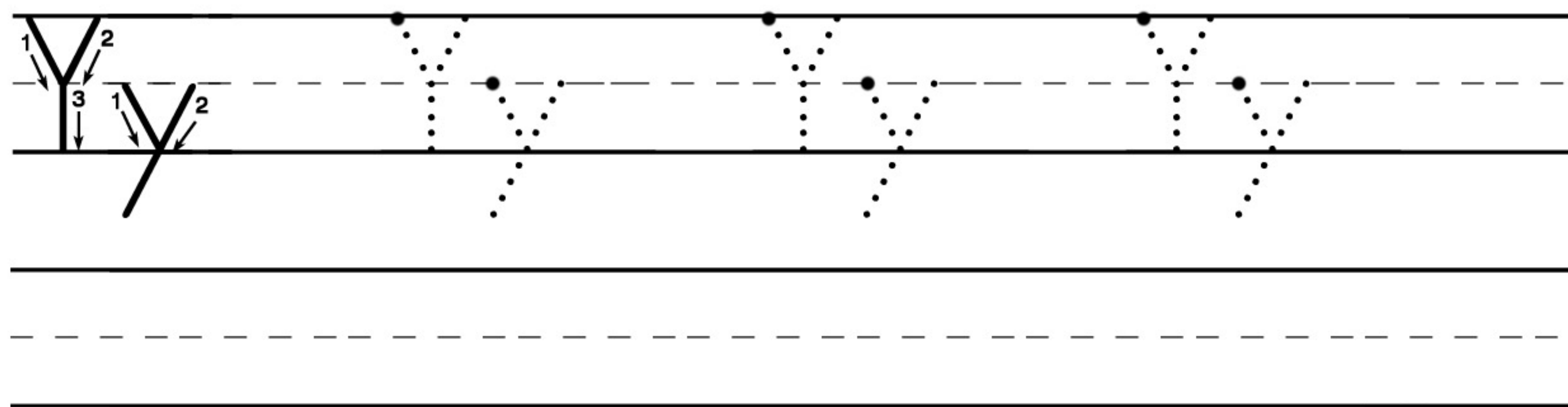



Name \_\_\_\_\_

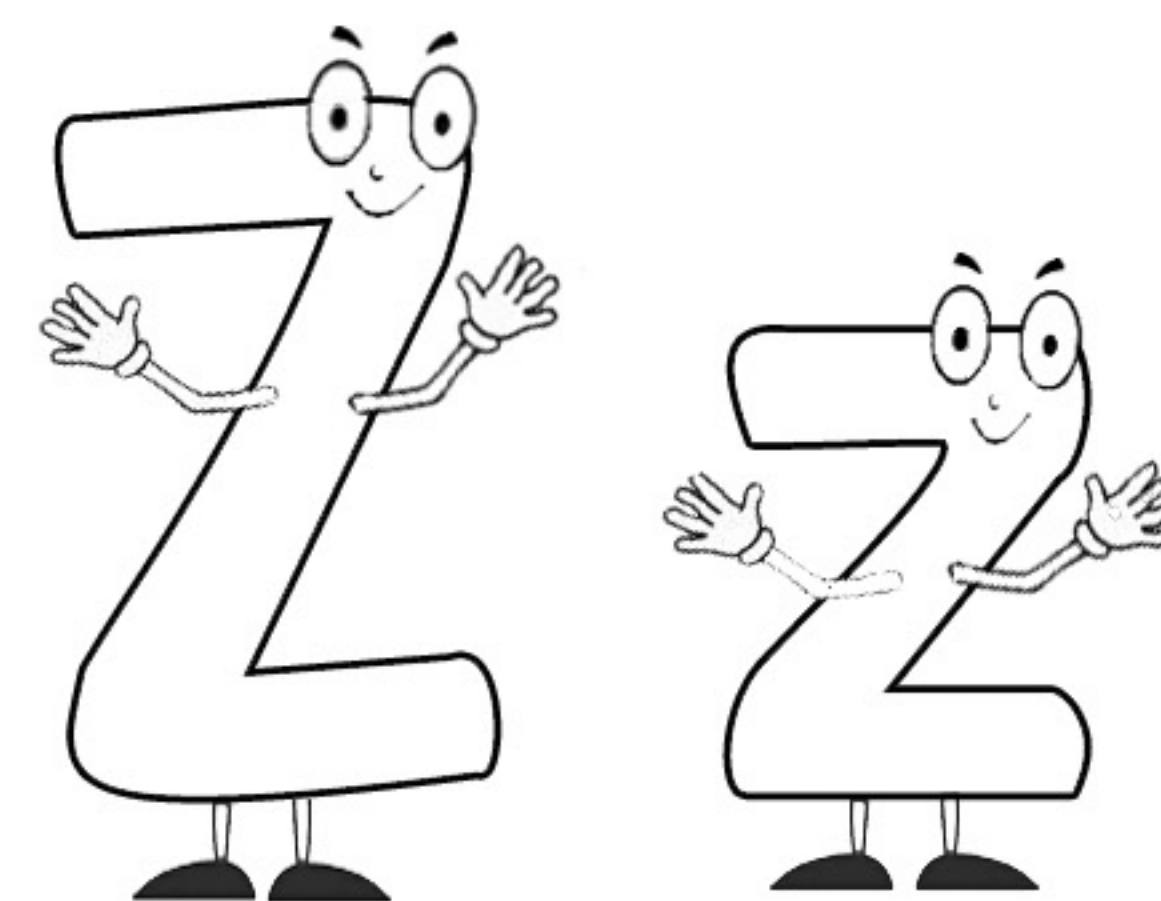
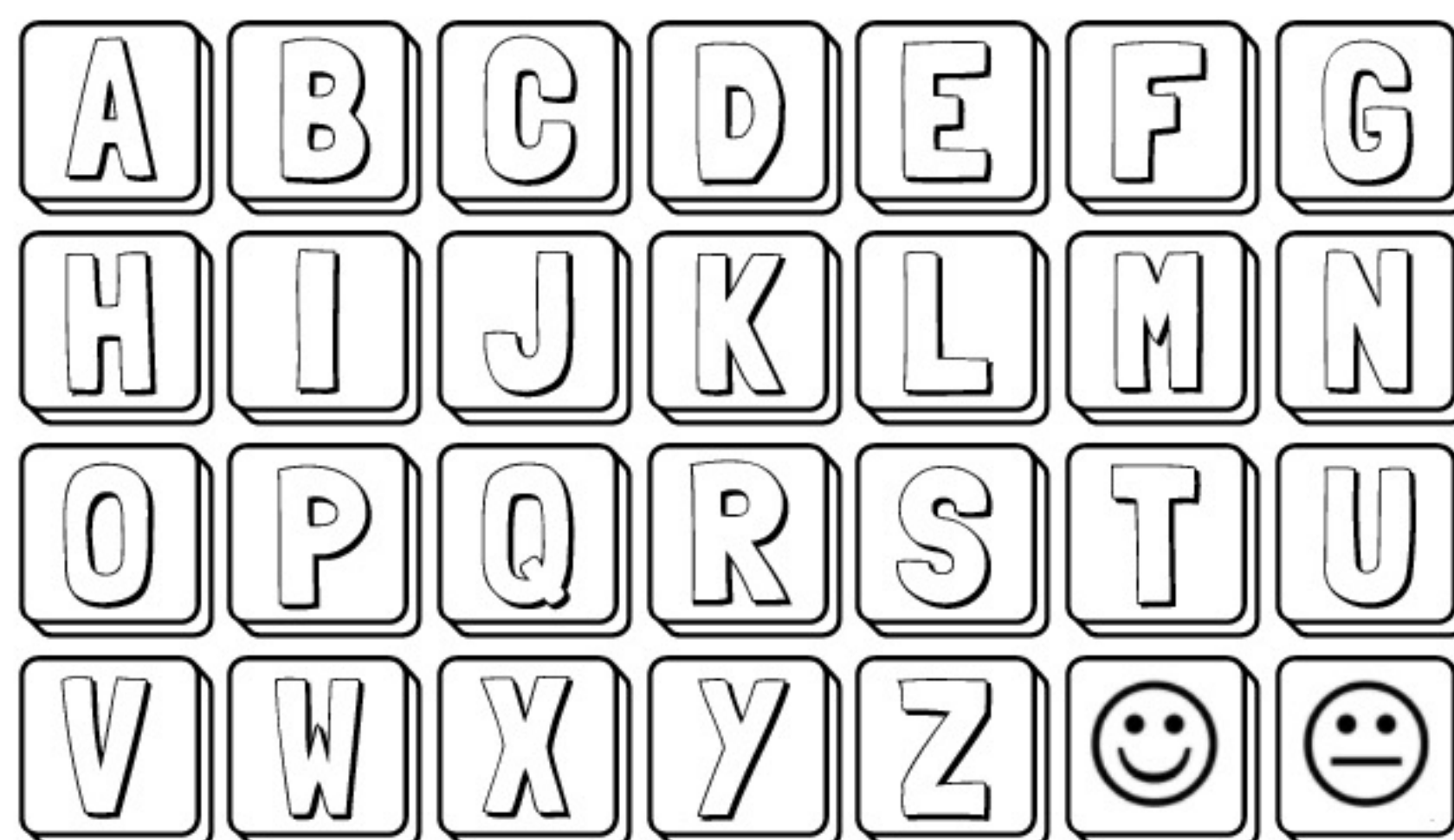

Circle Z and z.

Z w Y z W y z w Y Z  
W v z w Y Z V v z w  
z y V Z v W y z Z v  
V Z w y z v w V y z



Trace "z". read the words.

zag

zed

zip

zoo

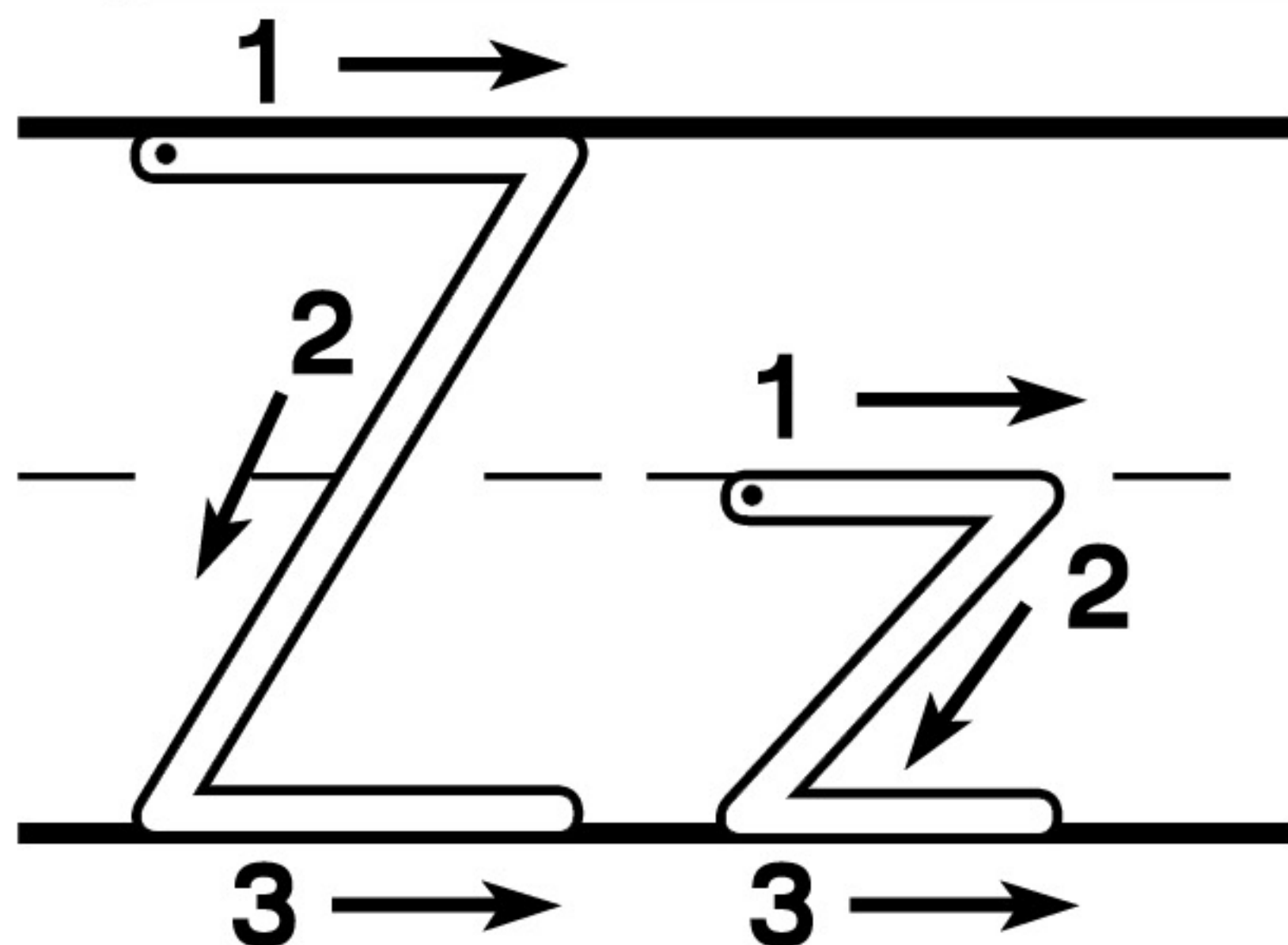

Trace and write. Follow the numbered arrows.

