



↓ تم تحميل ملف المادة من مكتبة طلابنا
زورونا على الموقع

www.tlabna.net

مكتبه طلابنا تقدم لكم كل ما يحتاج المعلم والمعلمه والطلبة , الطبعات الجديده للكتب والحلول ونماذج الاختبارات والتحاثير وشروحات الدروس بصيغة الورد والبي دي اف وكذلك عروض البوربوينت.



حُرُوفِي مَعَ الْفَتْحَةِ

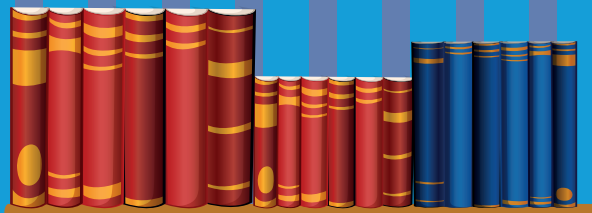

حَرْفُ الْأَيْفِ مَعَ الْفَتْحَةِ



حُرُوفِي مَعَ الْفَتْحَةِ

20

/

/

التَّارِيخُ:

العُمْرُ:

الاسْمُ:

2 لَوْنٌ بِالْأَلْوَانِ الْجَمِيلَةِ

1 مَرِّرِ الْقَلَمَ بِاتِّجَاهِ السَّهْمِ

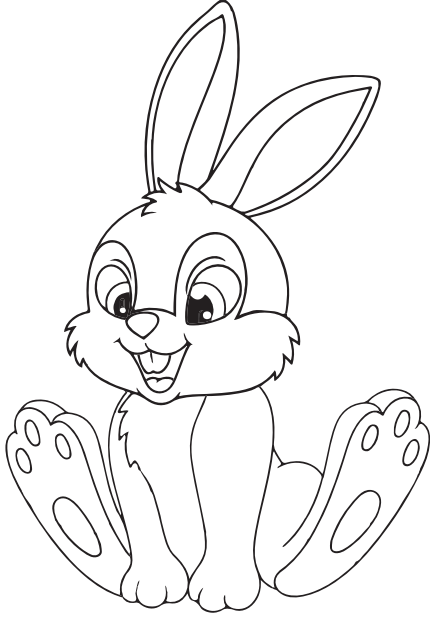

أَرْبَبٌ

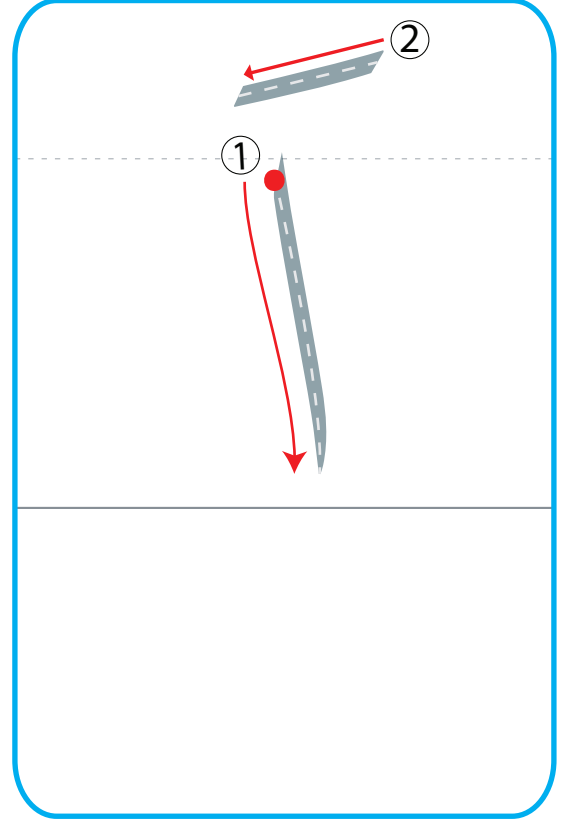

3 أَكْتُبِ الْحَرْفَ بِالشَّكْلِ الصَّحِيحِ





20

التَّارِيخُ:

العُمْرُ:

الاسْمُ:

2 لَوْنٌ بِالْأَلْوَانِ الْجَمِيلَةِ

1 مَرِّرِ الْقَلَمَ بِاتِّجَاهِ السَّهْمِ



بَيْتٌ

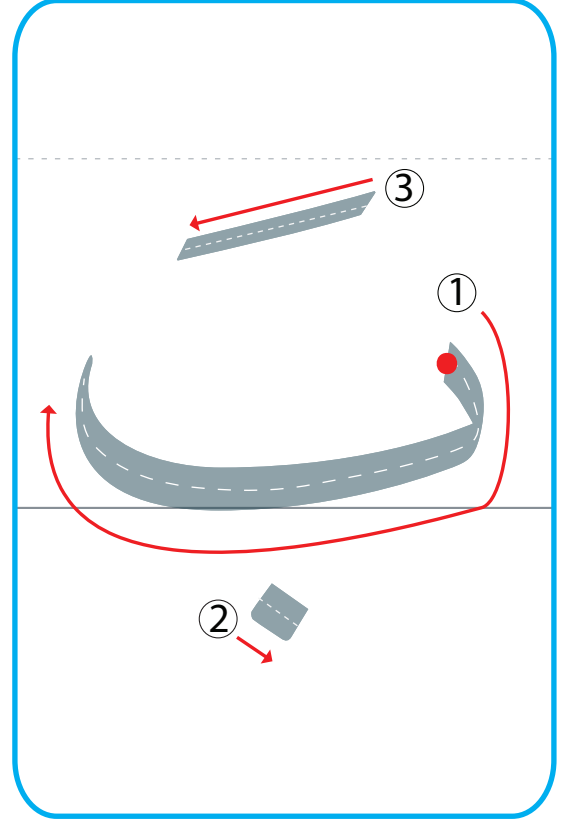

3 أَكْتُبِ الْحَرْفَ بِالشَّكْلِ الصَّحِيحِ

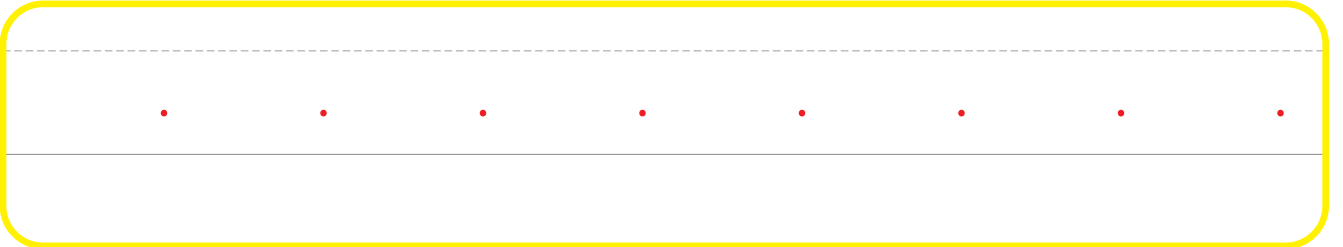
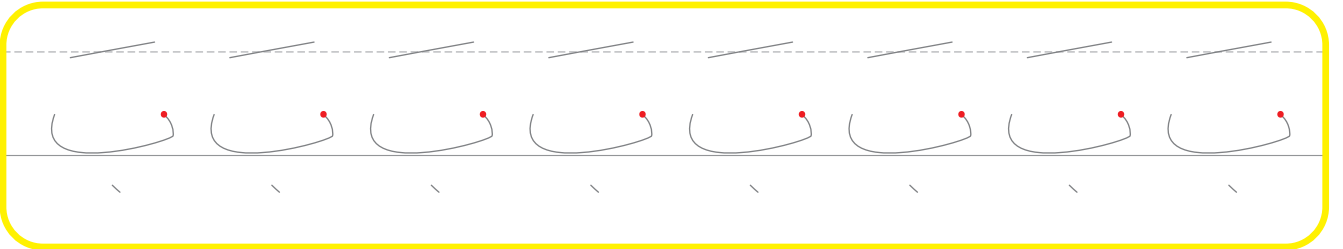
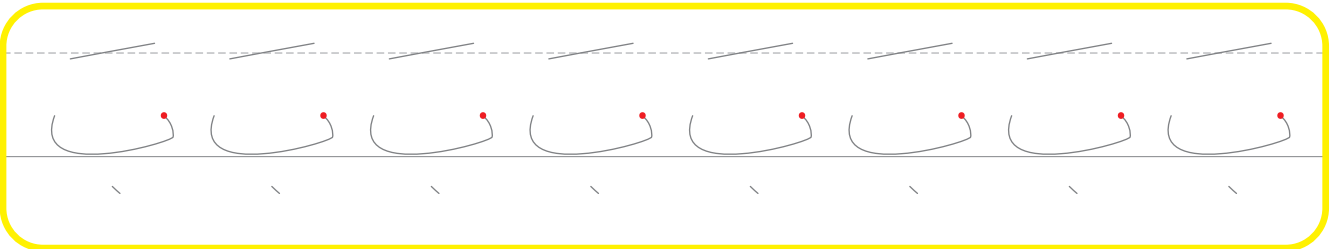



20

/

/

التَّارِيخُ:

العُمْرُ:

الاسْمُ:

2 لَوْنٌ بِالْأَلْوَانِ الْجَمِيلَةِ

1 مَرِّرِ الْقَلَمَ بِاتِّجَاهِ السَّهْمِ

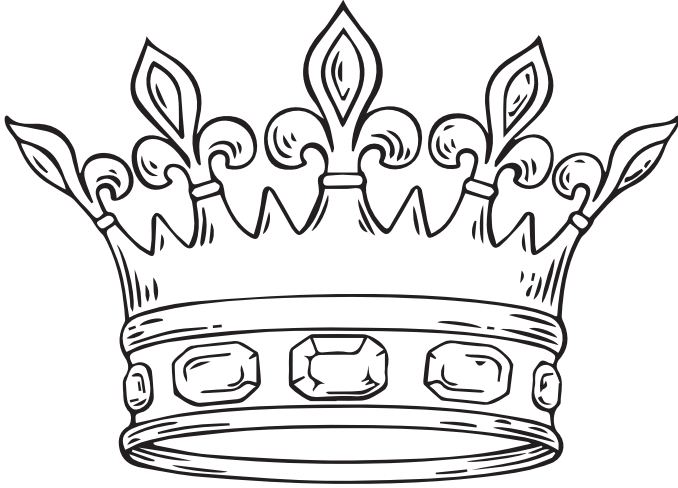

تاج

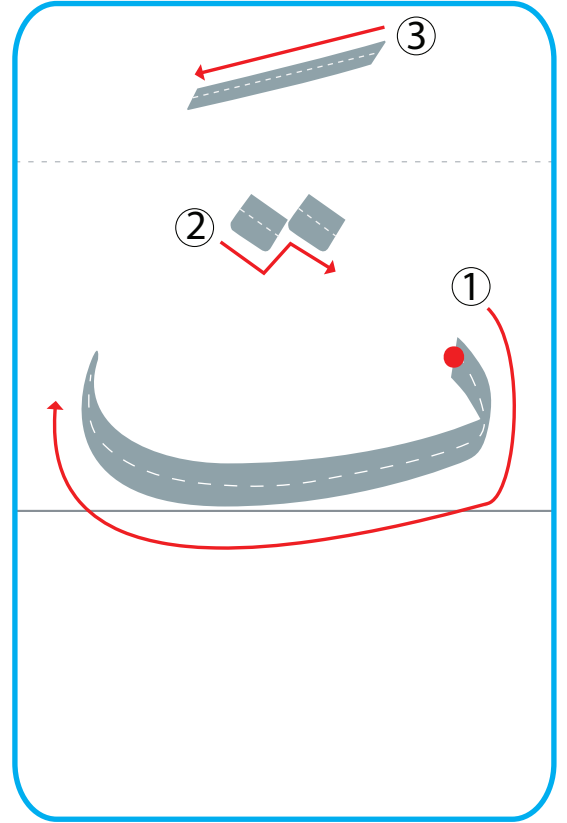

3 أَكْتُبِ الْحَرْفَ بِالشَّكْلِ الصَّحِيحِ

ت ت ت ت ت ت ت

ت ت ت ت ت ت ت

.



20

التَّارِيخُ:

العُمْرُ:

الاسْمُ:

2 لَوْنٌ بِالْأَلْوَانِ الْجَمِيلَةِ

1 مَرِّرِ الْقَلَمَ بِاتِّجَاهِ السَّهْمِ



تَعَلَّبَ

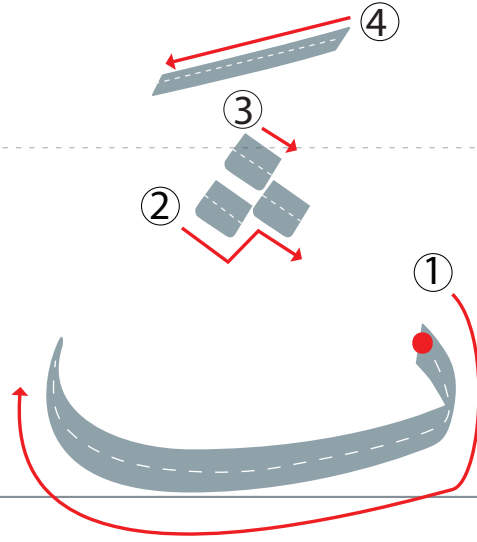

3 أَكْتُبِ الْحَرْفَ بِالشَّكْلِ الصَّحِيحِ

ث ث ث ث ث ث ث

ث ث ث ث ث ث ث

• • • • • • • •

حَرْفُ الْجِيمِ مَعَ الْفَتْحَةِ



حُرُوفِي مَعَ الْفَتْحَةِ

20

/ / التَّارِيخُ:

العُمْرُ:

الاسْمُ:

2 لَوْنٌ بِالْأَلْوَانِ الْجَمِيلَةِ

1 مَرِّرِ الْقَلَمَ بِاتِّجَاهِ السَّهْمِ

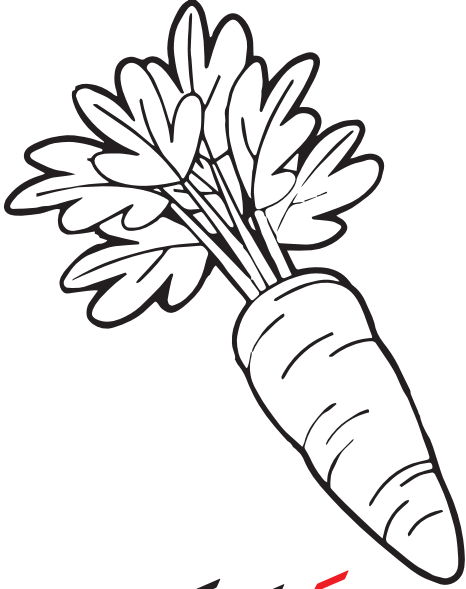

جَزَرَةٌ

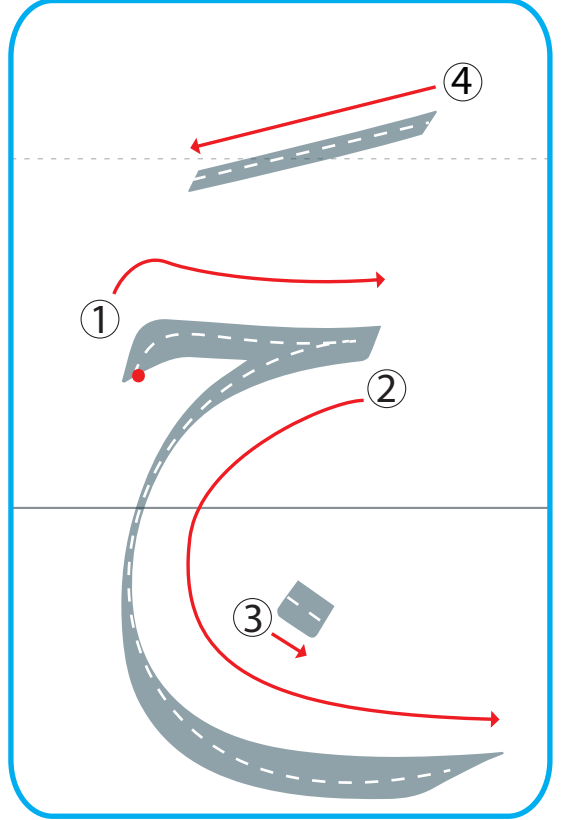

3 أَكْتُبِ الْحَرْفَ بِالشَّكْلِ الصَّحِيحِ

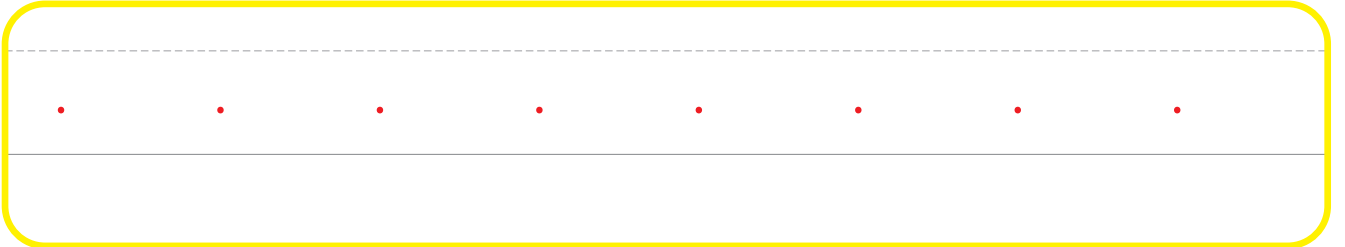
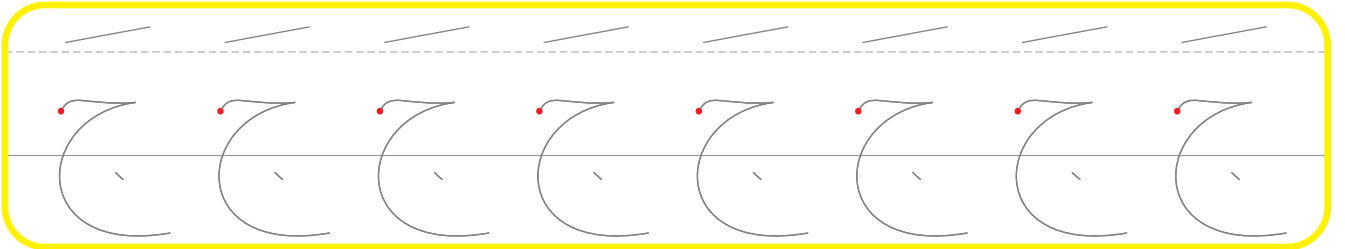
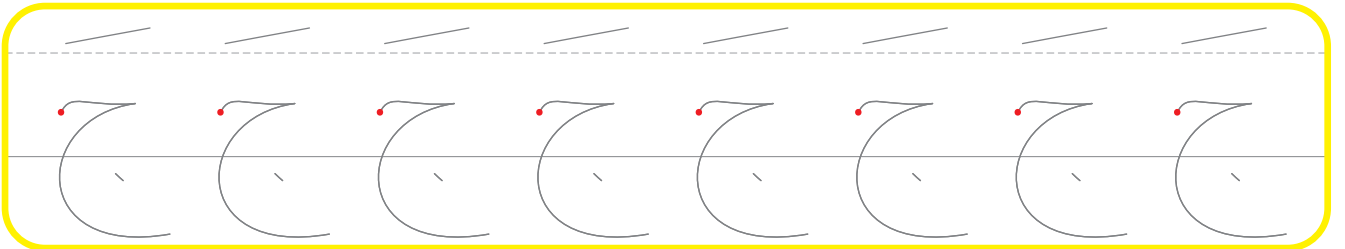



20

/ / التَّارِيخُ:

العُمْرُ:

الاسْمُ:

2 لَوْنٌ بِالألْوَانِ الجَمِيلَةِ

1 مَرَّرِ القَلَمَ بِاتِّجَاهِ السَّهْمِ



حَبْلٌ

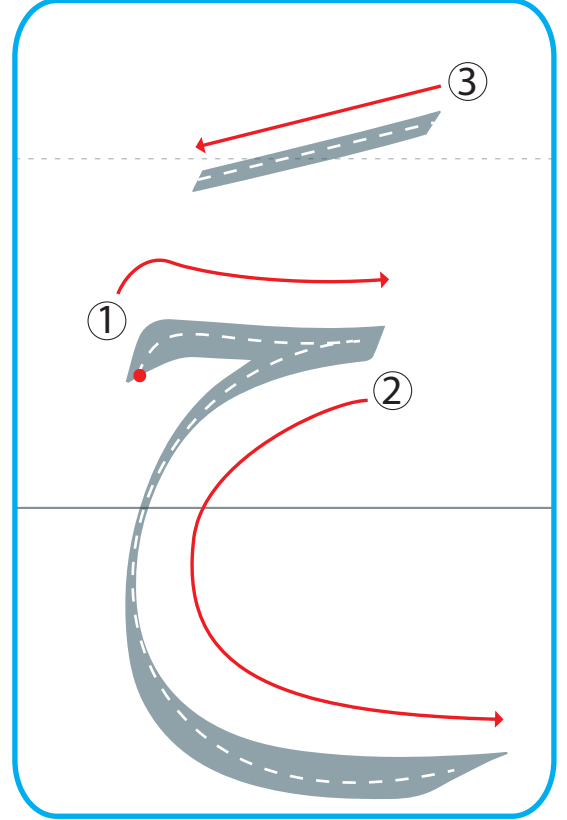

3 أَكْتُبِ الحَرْفَ بِالشَّكْلِ الصَّحِيحِ

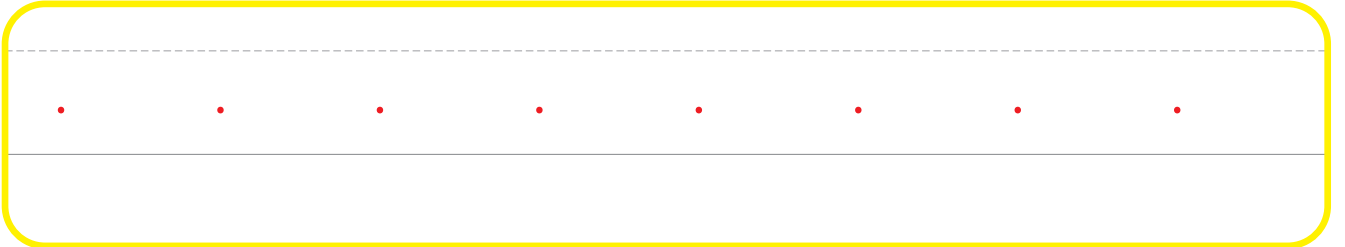
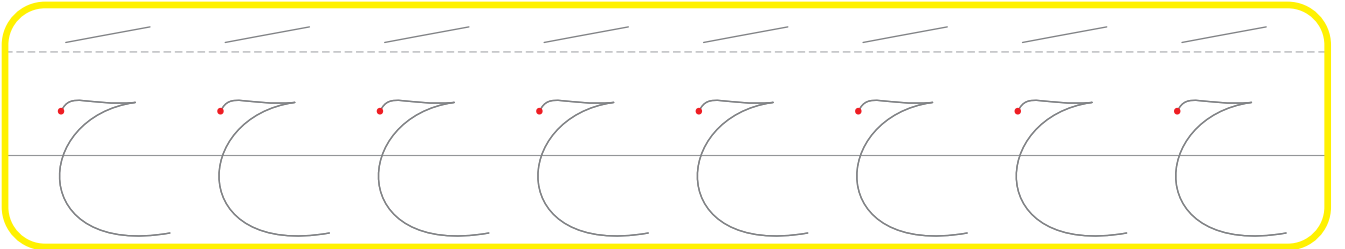
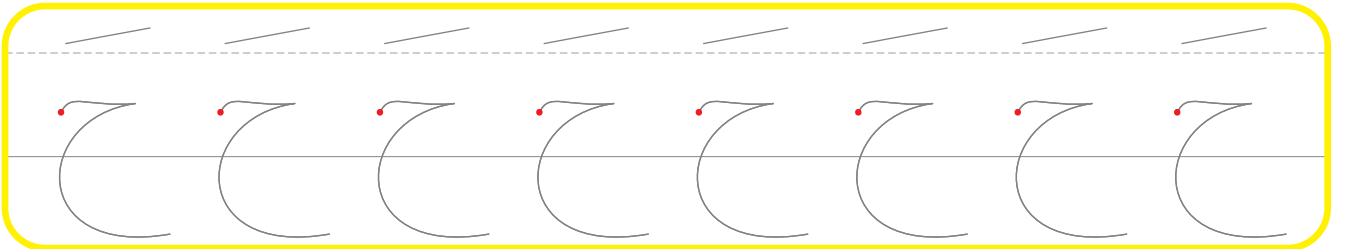



20

التَّارِيخُ:

العُمْرُ:

الاسْمُ:

2 لَوْنٌ بِالألوانِ الجَمِيلَةِ

1 مَرِّرِ القَلَمَ بِاتِّجَاهِ السَّهْمِ

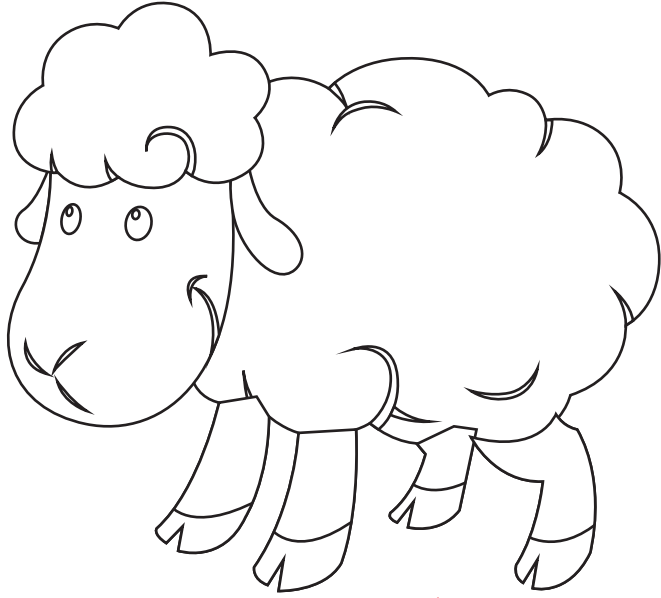

خروف

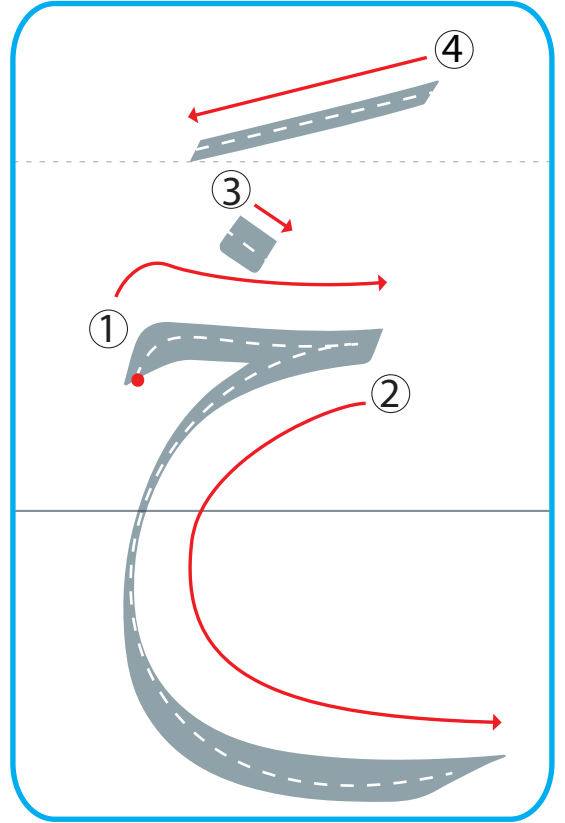

3 أَكْتُبِ الحَرْفَ بِالشَّكْلِ الصَّحِيحِ

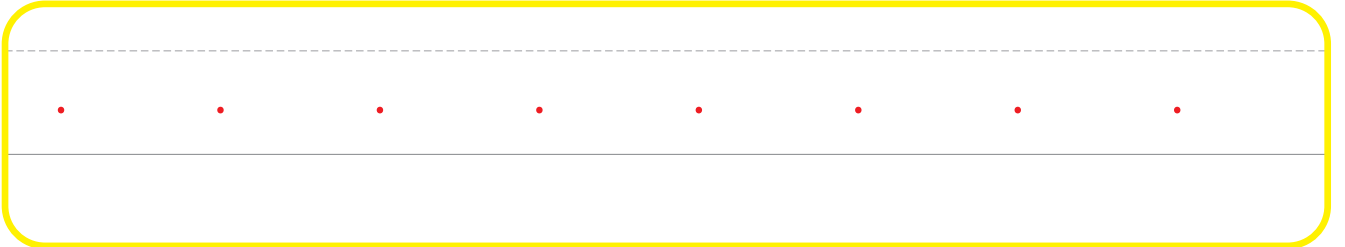
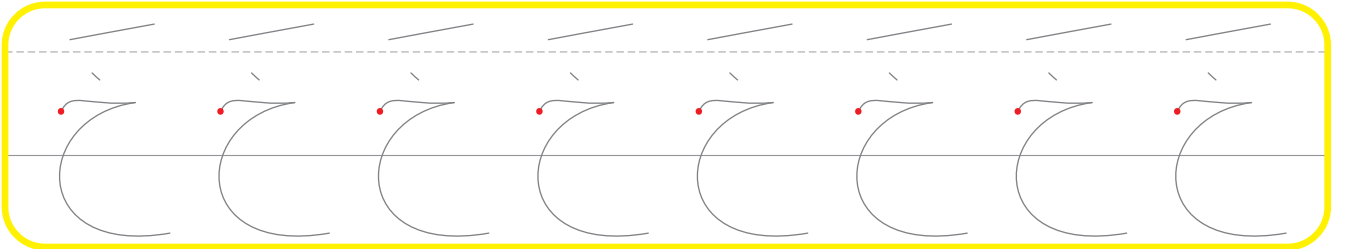
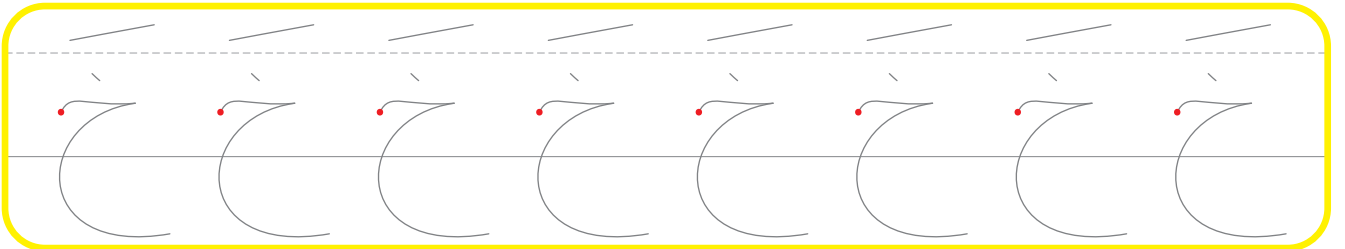



20

/ /

التَّارِيخُ:

العُمْرُ:

الاسْمُ:

2 لَوْنٌ بِالْأَلْوَانِ الْجَمِيلَةِ

1 مَرَّرِ الْقَلَمَ بِاتِّجَاهِ السَّهْمِ

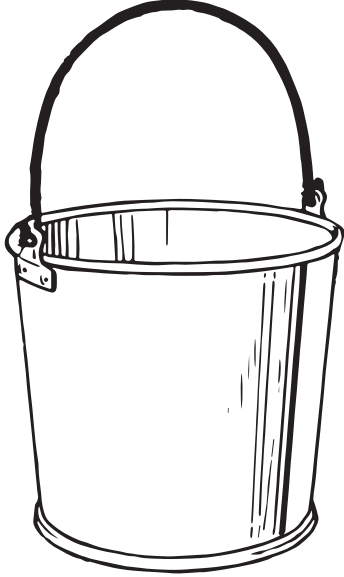

دَلُو

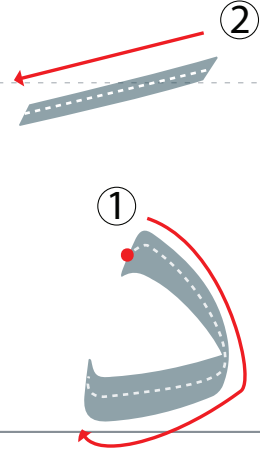

3 أَكْتُبِ الْحَرْفَ بِالشَّكْلِ الصَّحِيحِ

د د د د د د د د

د د د د د د د د

.



20

/ /

التَّارِيخُ:

العُمْرُ:

الاسْمُ:

2 لَوْنٌ بِالْأَلْوَانِ الْجَمِيلَةِ

1 مَرَّرِ الْقَلَمَ بِاتِّجَاهِ السَّهْمِ

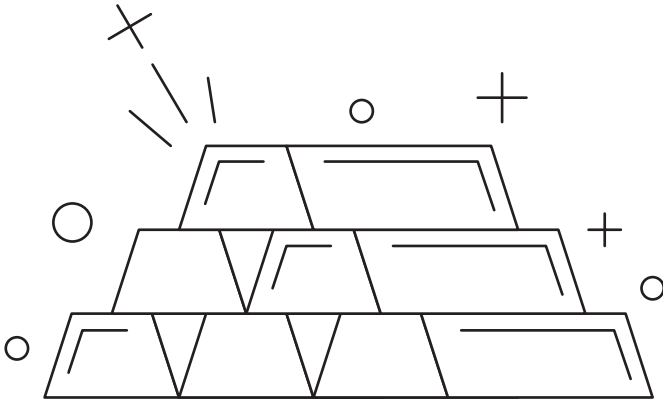

ذَهَبٌ

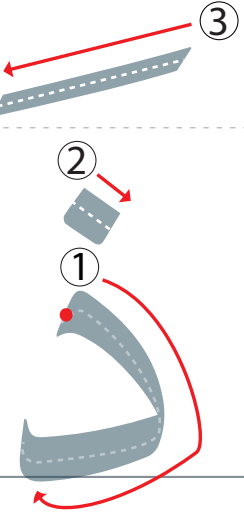

3 أَكْتُبِ الْحَرْفَ بِالشَّكْلِ الصَّحِيحِ

ذ ذ ذ ذ ذ ذ ذ ذ

ذ ذ ذ ذ ذ ذ ذ ذ

• • • • • • • •



20

/

/

التَّارِيخُ:

العُمْرُ:

الاسْمُ:

2 لَوْنٌ بِالْأَلْوَانِ الْجَمِيلَةِ

1 مَرِّرِ الْقَلَمَ بِاتِّجَاهِ السَّهْمِ



رَجُلٌ

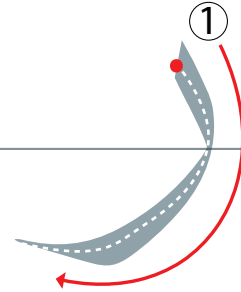
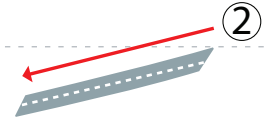

3 أَكْتُبِ الْحَرْفَ بِالشَّكْلِ الصَّحِيحِ

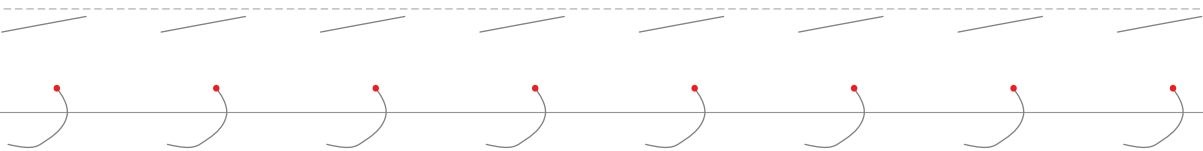
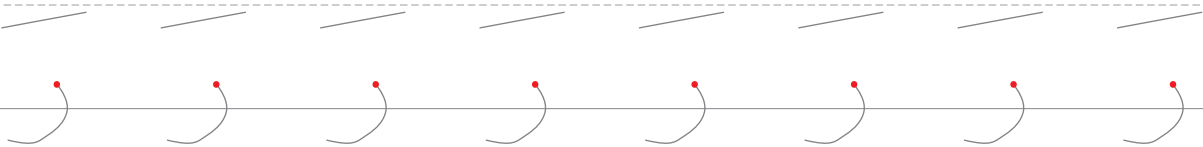

حَرْفُ الزَّامِعِ الْفَتْحَةِ



حُرُوفِي مَعَ الْفَتْحَةِ

20

التَّارِيخُ:

العُمْرُ:

الاسْمُ:

2 لَوْنٌ بِالْأَلْوَانِ الْجَمِيلَةِ

1 مَرِّرِ الْقَلَمَ بِاتِّجَاهِ السَّهْمِ

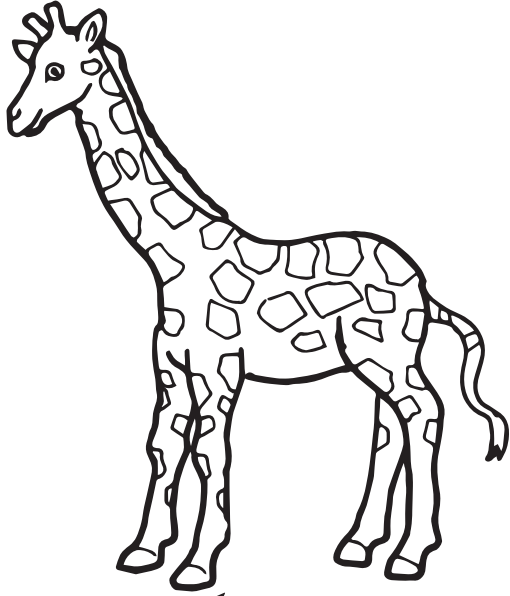

زرافة

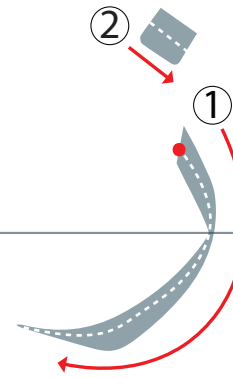
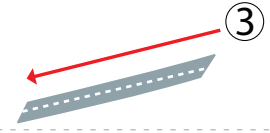

3 أَكْتُبِ الْحَرْفَ بِالشَّكْلِ الصَّحِيحِ

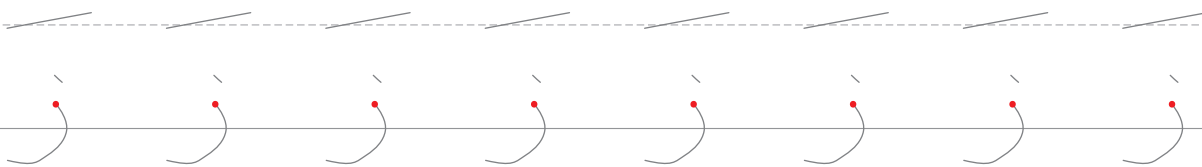
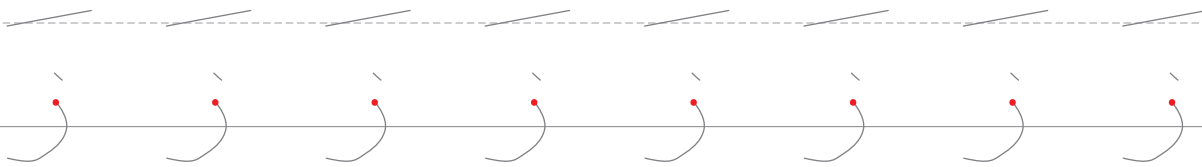



20

/ / التَّارِيخُ:

العُمْرُ:

الاسْمُ:

2 لَوْنٌ بِالْأَلْوَانِ الْجَمِيلَةِ

1 مَرَّرِ الْقَلَمَ بِاتِّجَاهِ السَّهْمِ

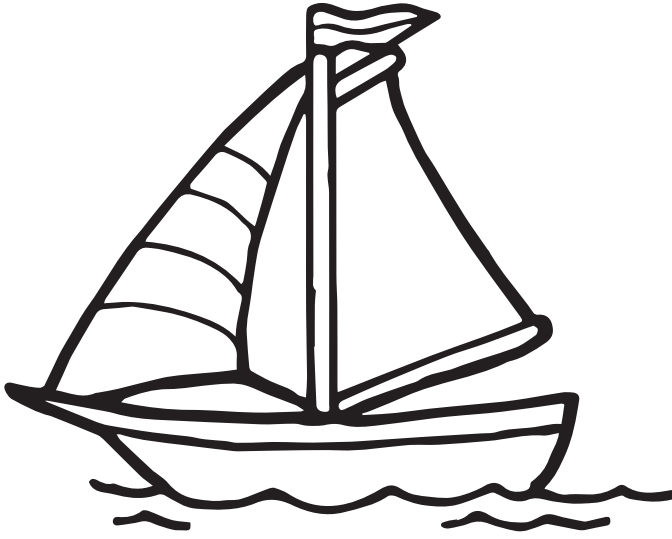

سَفِينَةٌ

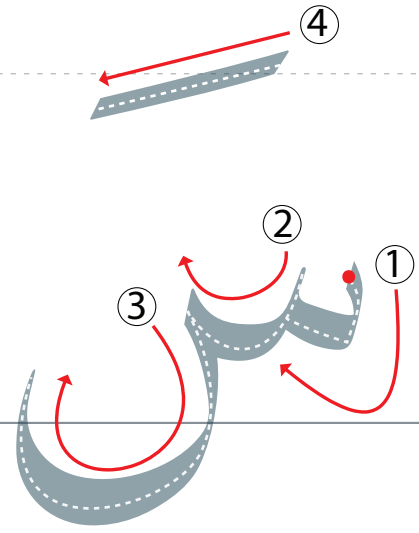

3 أَكْتُبِ الْحَرْفَ بِالشَّكْلِ الصَّحِيحِ

س س س س س س س س

س س س س س س س س

• • • • • • • •



20

التَّارِيخُ:

العُمْرُ:

الاسْمُ:

2 لَوْنٌ بِالْأَلْوَانِ الْجَمِيلَةِ

1 مَرَّرِ الْقَلَمَ بِاتِّجَاهِ السَّهْمِ



شَمْعَةٌ

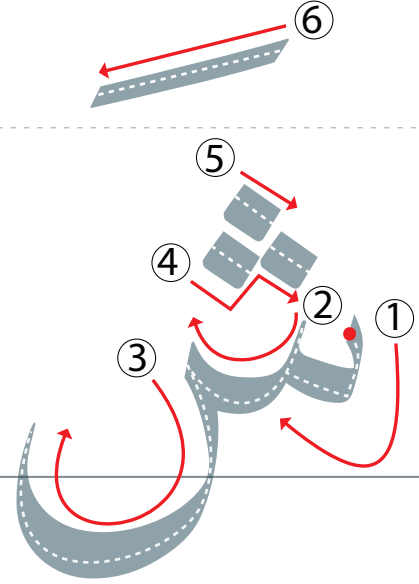

3 أَكْتُبِ الْحَرْفَ بِالشَّكْلِ الصَّحِيحِ

ش ش ش ش ش ش ش ش

ش ش ش ش ش ش ش ش

• • • • • • • •



20

/ / التَّارِيخُ:

العُمْرُ:

الاسْمُ:

2 لَوْنٌ بِالْأَلْوَانِ الْجَمِيلَةِ

1 مَرِّرِ الْقَلَمَ بِاتِّجَاهِ السَّهْمِ

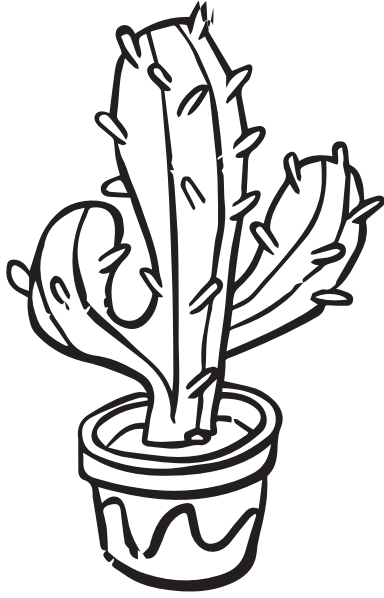

صَبَّارٌ

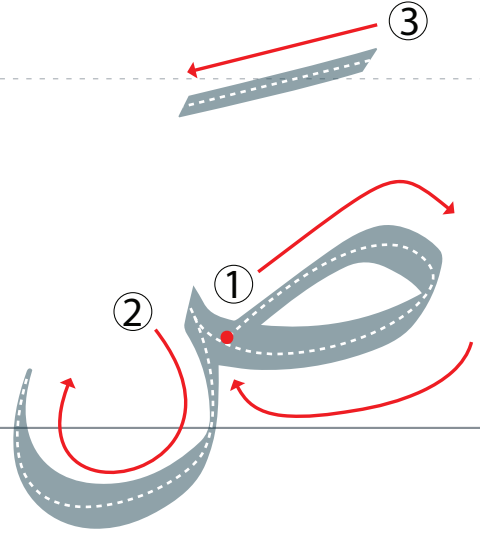

3 أَكْتُبِ الْحَرْفَ بِالشَّكْلِ الصَّحِيحِ

ص ص ص ص ص ص ص ص

ص ص ص ص ص ص ص ص

• • • • • • • •



20

التَّارِيخُ:

العُمْرُ:

الاسْمُ:

2 لَوْنٌ بِالْأَلْوَانِ الْجَمِيلَةِ

1 مَرَّرِ الْقَلَمَ بِاتِّجَاهِ السَّهْمِ

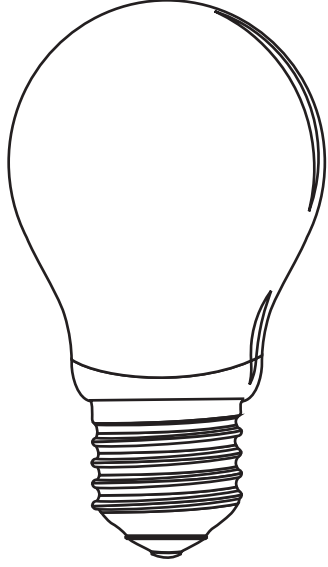

ضوء

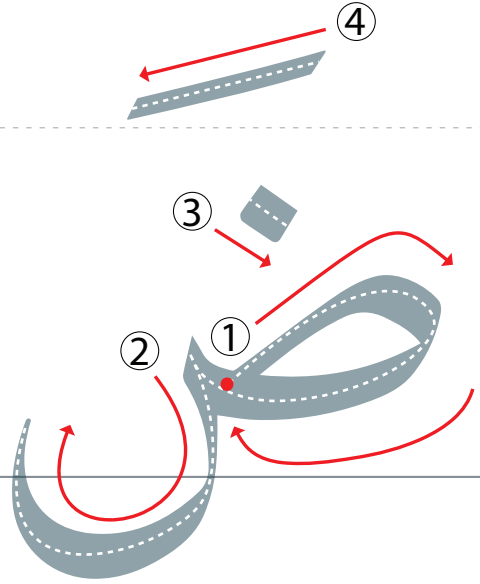

3 أَكْتُبِ الْحَرْفَ بِالشَّكْلِ الصَّحِيحِ

ض ض ض ض ض ض ض ض

ض ض ض ض ض ض ض ض

• • • • • • • •



20

التَّارِيخُ:

العُمْرُ:

الاسْمُ:

2 لَوْنٌ بِالْأَلْوَانِ الْجَمِيلَةِ

1 مَرَّرِ الْقَلَمَ بِاتِّجَاهِ السَّهْمِ

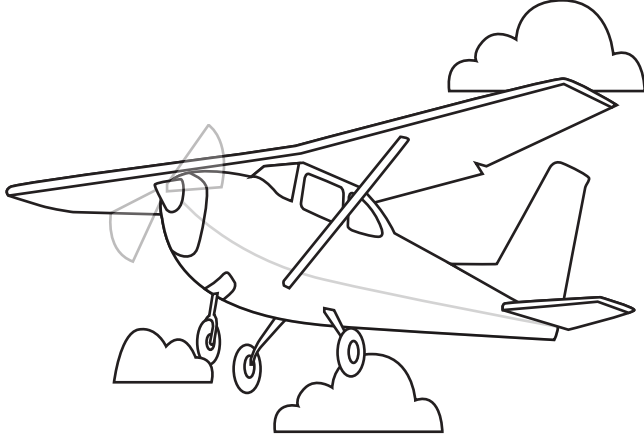

طَائِرَةٌ

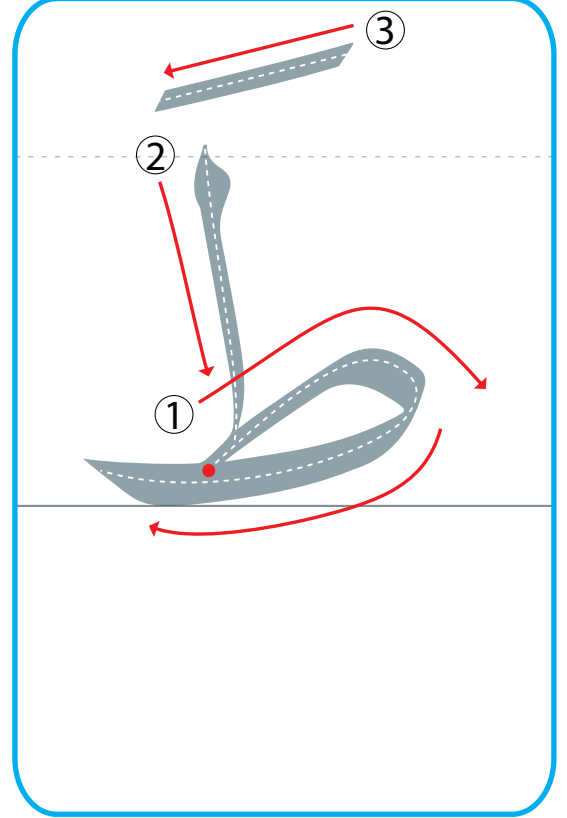

3 أَكْتُبِ الْحَرْفَ بِالشَّكْلِ الصَّحِيحِ

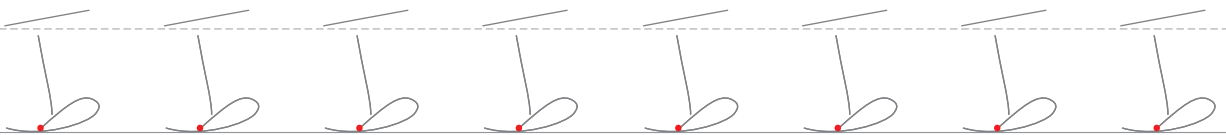
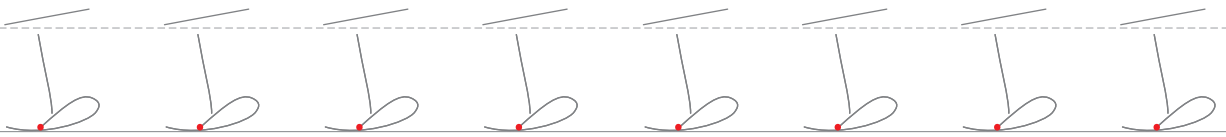



20

التَّارِيخُ:

العُمْرُ:

الاسْمُ:

2 لَوْنٌ بِالْأَلْوَانِ الْجَمِيلَةِ

1 مَرَّرَ الْقَلَمَ بِاتِّجَاهِ السَّهْمِ

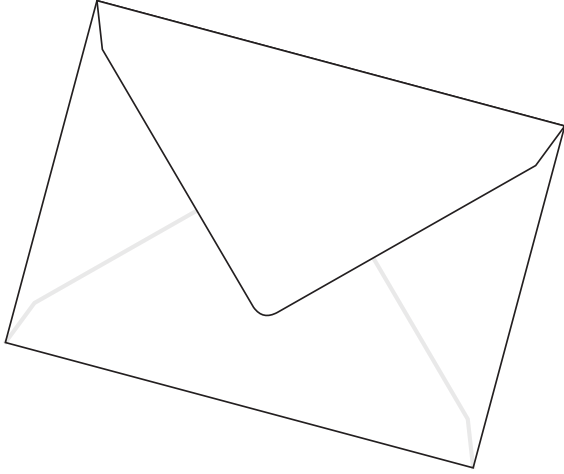

ظَرْفٌ

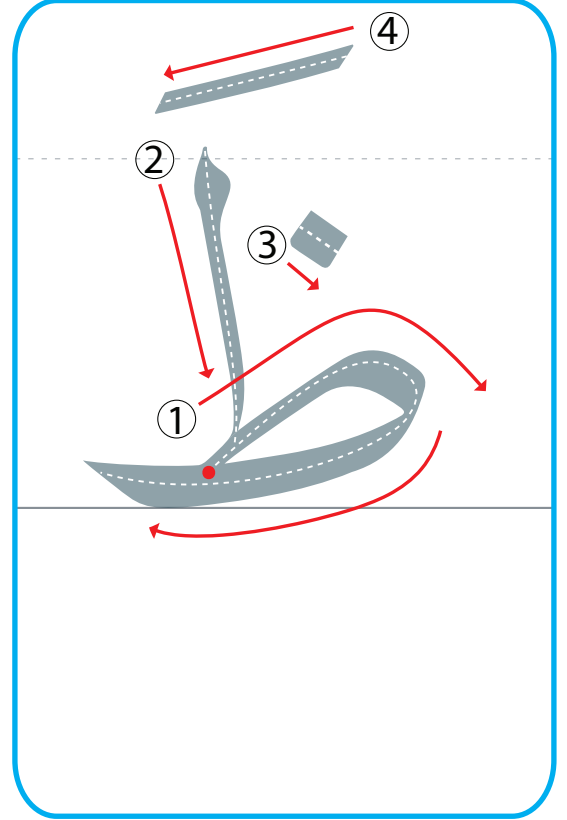

3 أَكْتُبِ الْحَرْفَ بِالشَّكْلِ الصَّحِيحِ

ظ ظ ظ ظ ظ ظ ظ ظ

ظ ظ ظ ظ ظ ظ ظ ظ

ظ ظ ظ ظ ظ ظ ظ ظ



20

التَّارِيخُ:

العُمْرُ:

الاسْمُ:

2 لَوْنٌ بِالْأَلْوَانِ الْجَمِيلَةِ

1 مَرَّرِ الْقَلَمَ بِاتِّجَاهِ السَّهْمِ



عَسَلٌ

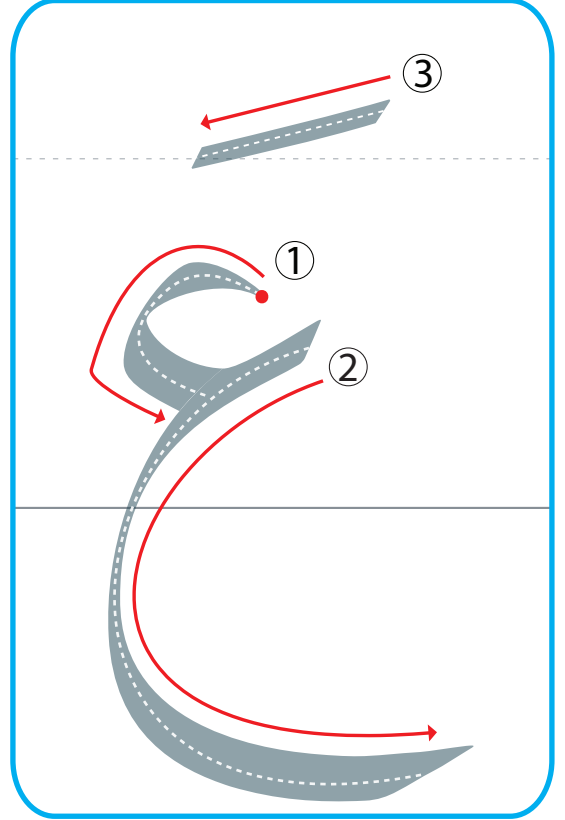

3 أَكْتُبِ الْحَرْفَ بِالشَّكْلِ الصَّحِيحِ

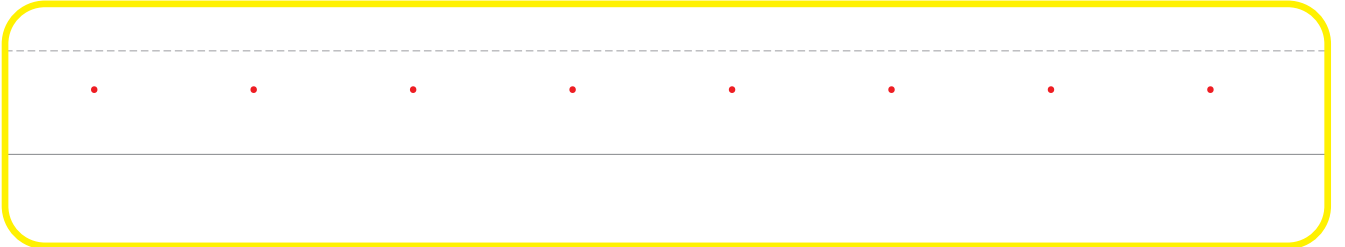
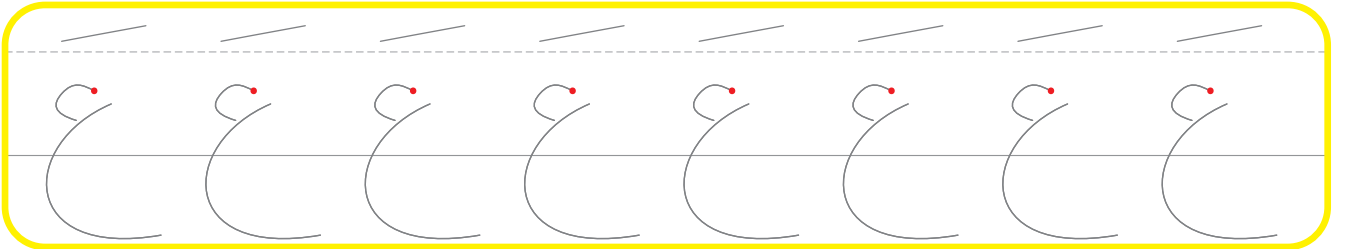
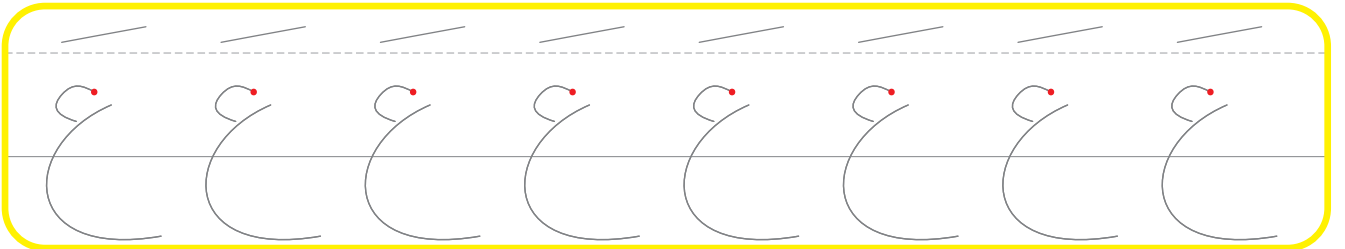

حَرْفُ الْغَيْنِ مَعَ الْفَتْحَةِ



حُرُوفِي مَعَ الْفَتْحَةِ

20

التَّارِيخُ:

العُمْرُ:

الاسْمُ:

2 لَوْنٌ بِالْأَلْوَانِ الْجَمِيلَةِ

1 مَرَّرِ الْقَلَمَ بِاتِّجَاهِ السَّهْمِ

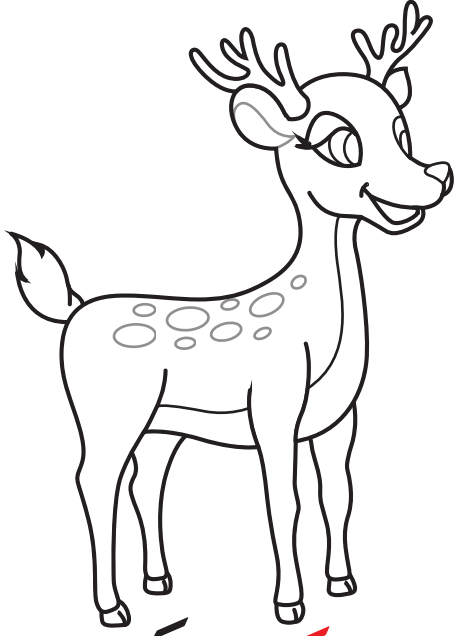

غَزَالَةٌ

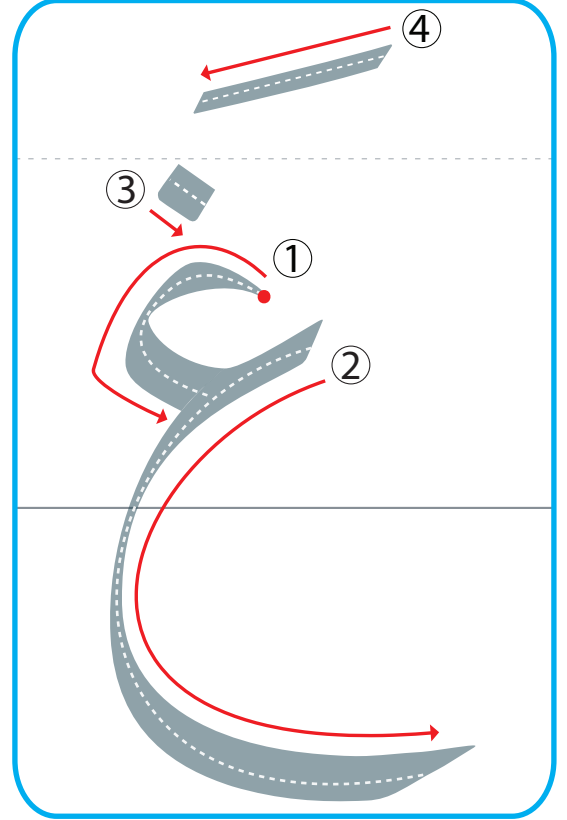

3 أَكْتُبِ الْحَرْفَ بِالشَّكْلِ الصَّحِيحِ

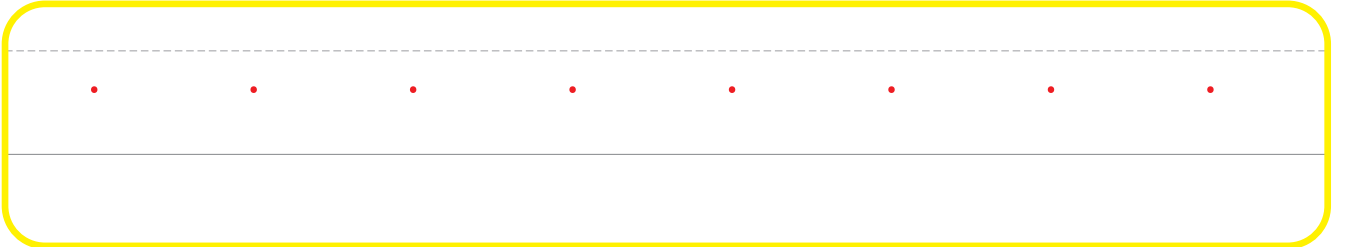
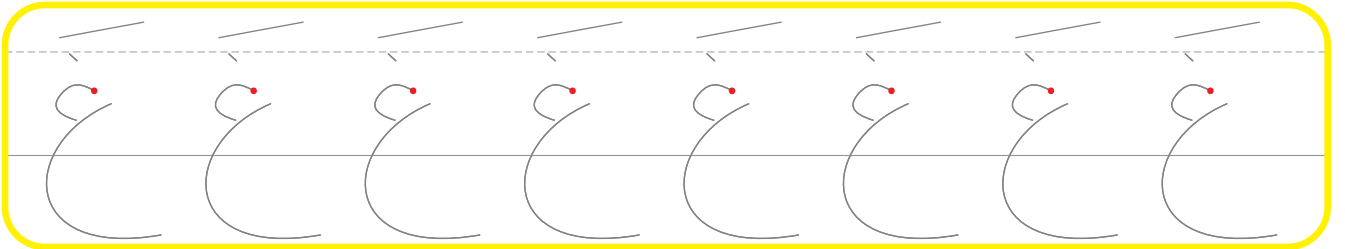
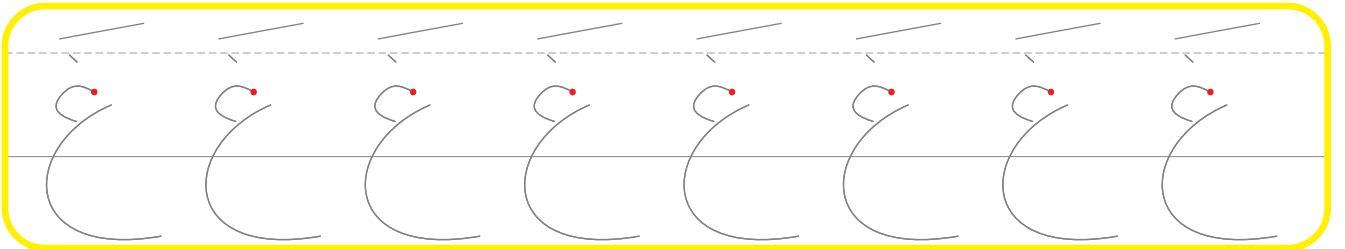

20 / / : التَّارِيخُ:

العُمْرُ:

الاسْمُ:

2 لَوْنٌ بِالْأَلْوَانِ الْجَمِيلَةِ

1 مَرَّرِ الْقَلَمَ بِاتِّجَاهِ السَّهْمِ

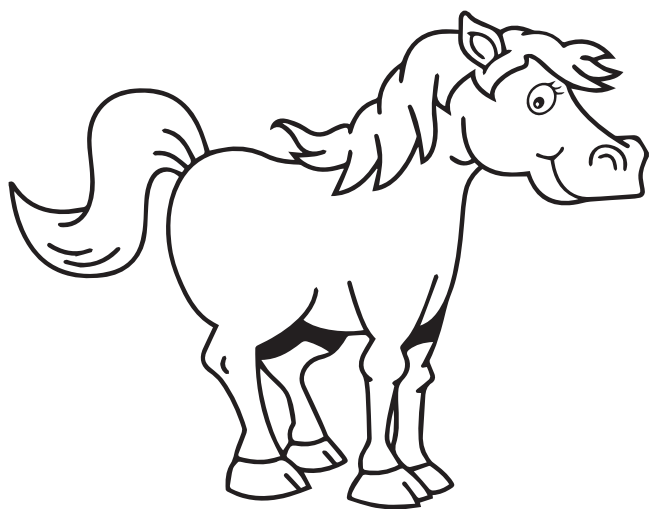

فَرَسٌ

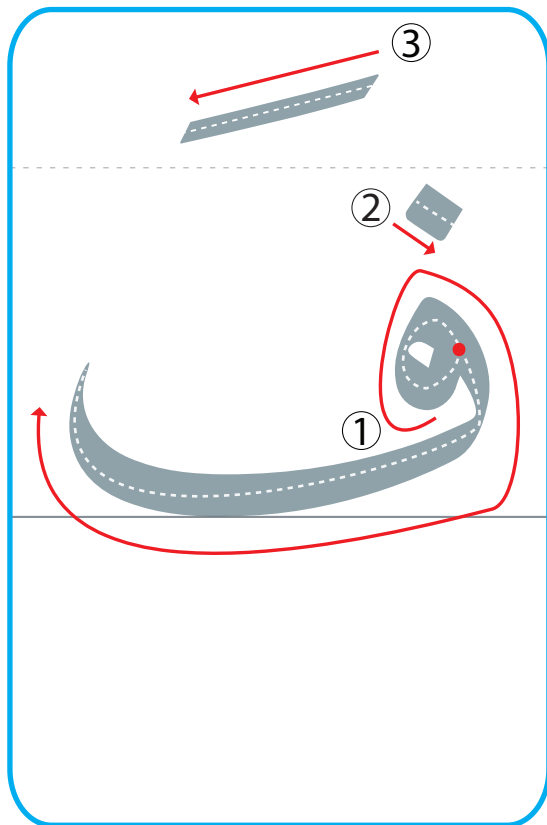

3 اُكْتُبِ الْحَرْفَ بِالشَّكْلِ الصَّحِيحِ

ف ف ف ف ف ف ف ف ف

ف ف ف ف ف ف ف ف ف

.



20 / /

التَّارِيخُ:

العُمْرُ:

الاسْمُ:

2 لَوْنٌ بِالْأَلْوَانِ الْجَمِيلَةِ

1 مَرِّرِ الْقَلَمَ بِاتِّجَاهِ السَّهْمِ

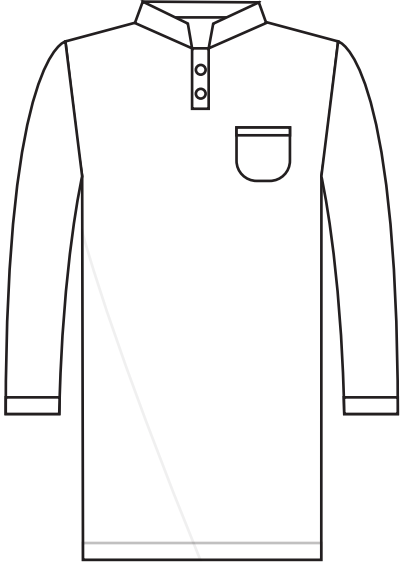

قميص

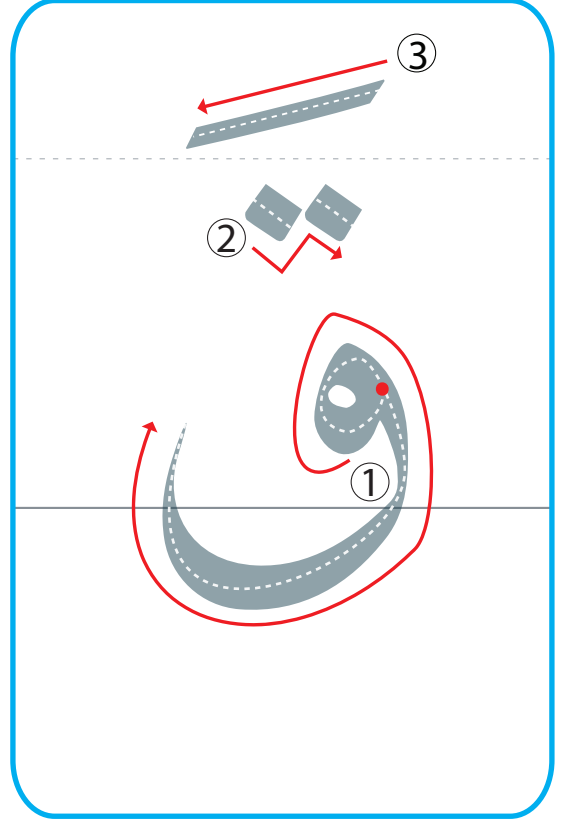

3 اُكْتُبِ الْحَرْفَ بِالشَّكْلِ الصَّحِيحِ

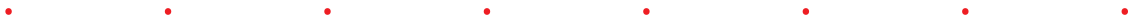
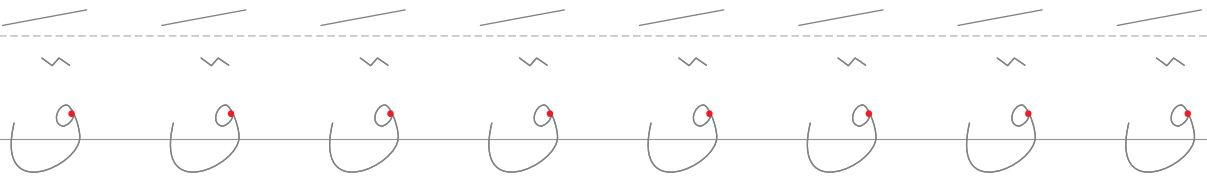
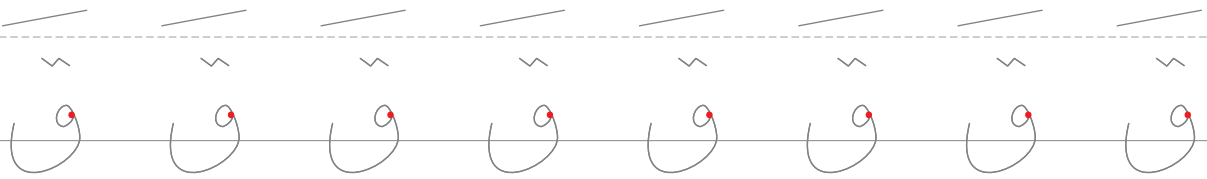



20

التَّارِيخُ:

العُمْرُ:

الاسْمُ:

2 لَوْنٌ بِالْأَلْوَانِ الْجَمِيلَةِ

1 مَرَّرِ الْقَلَمَ بِاتِّجَاهِ السَّهْمِ

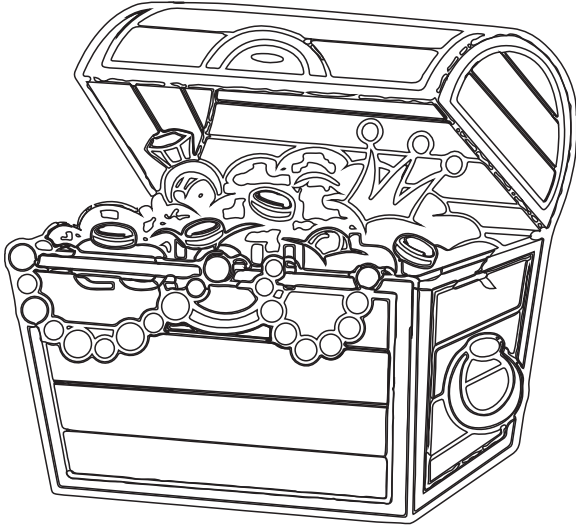

كَنْزٌ

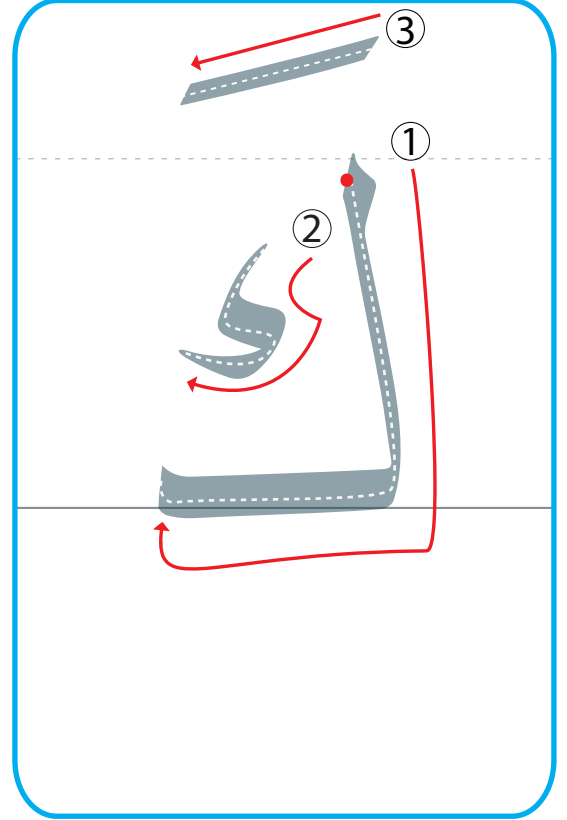

3 أَكْتُبِ الْحَرْفَ بِالشَّكْلِ الصَّحِيحِ

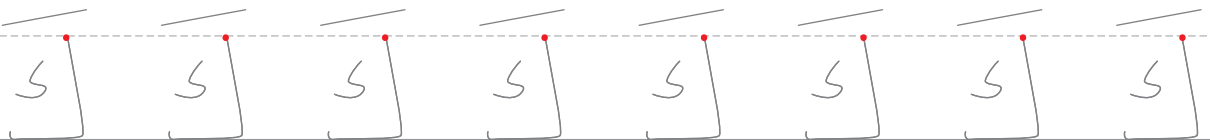
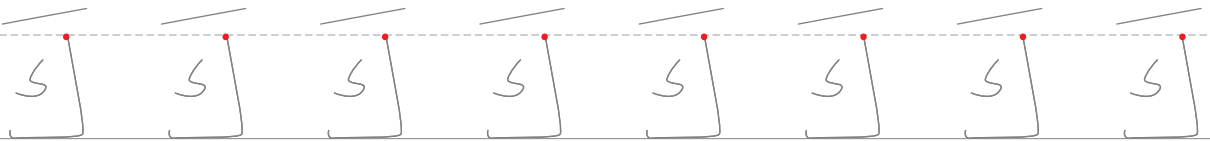



20

/ / التَّارِيخُ:

العُمْرُ:

الاسْمُ:

2 لَوْنٌ بِالْأَلْوَانِ الْجَمِيلَةِ

1 مَرَّرِ الْقَلَمَ بِاتِّجَاهِ السَّهْمِ

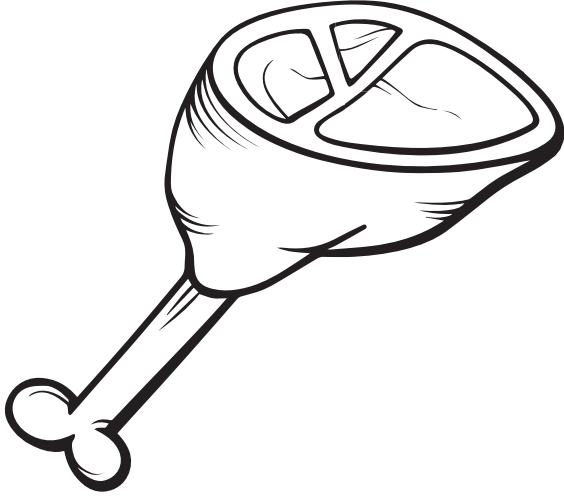

لَحْمٌ

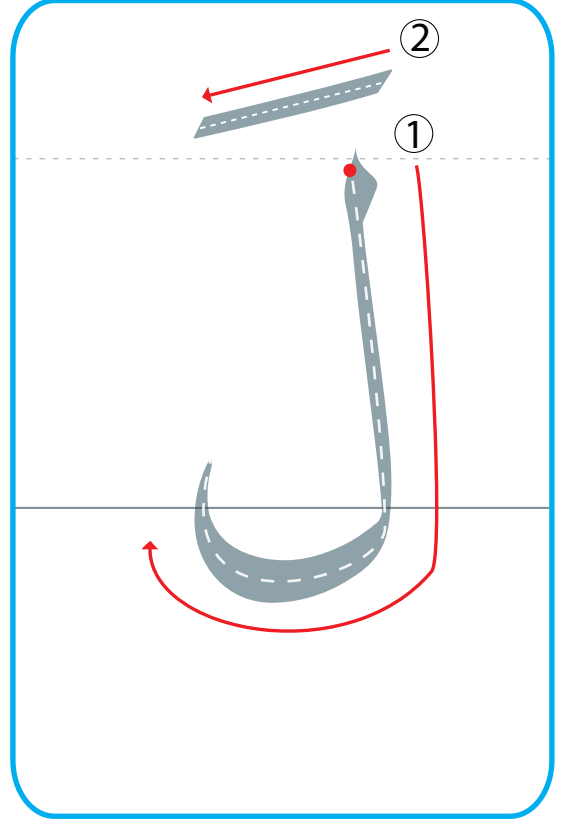

3 أَكْتُبِ الْحَرْفَ بِالشَّكْلِ الصَّحِيحِ

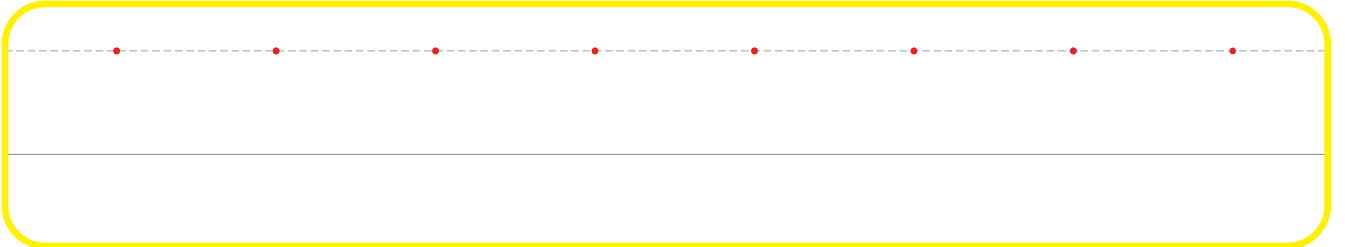
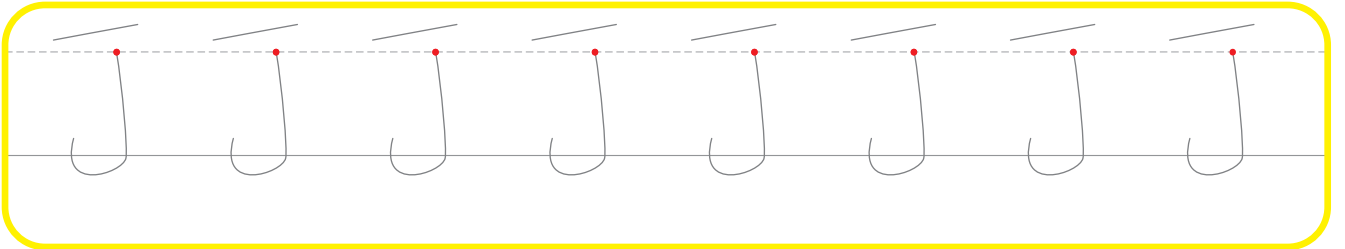
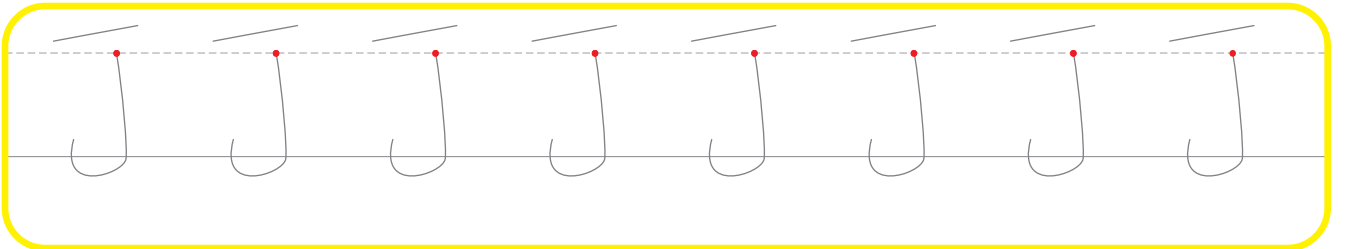

حَرْفُ المِيمِ مَعَ الفَتْحَةِ



حُرُوفِي مَعَ الفَتْحَةِ

20

/ / التَّارِيخُ:

العُمْرُ:

الاسْمُ:

2 لَوْنٌ بِالألوانِ الجَمِيلَةِ

1 مَرِّرِ القَلَمَ بِاتِّجَاهِ السَّهْمِ

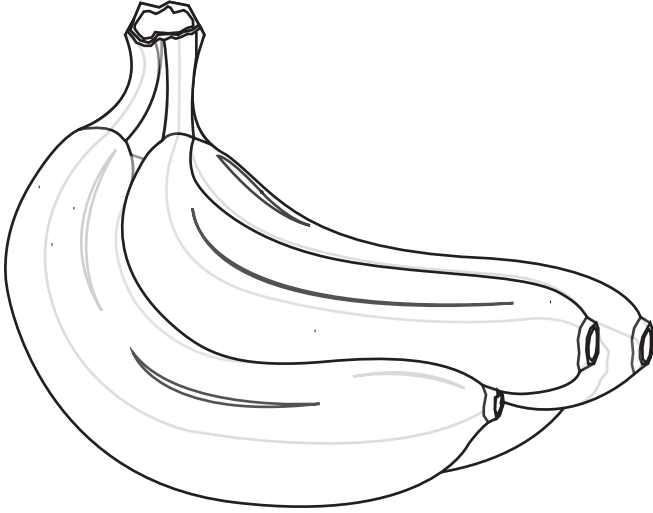

مَوْز

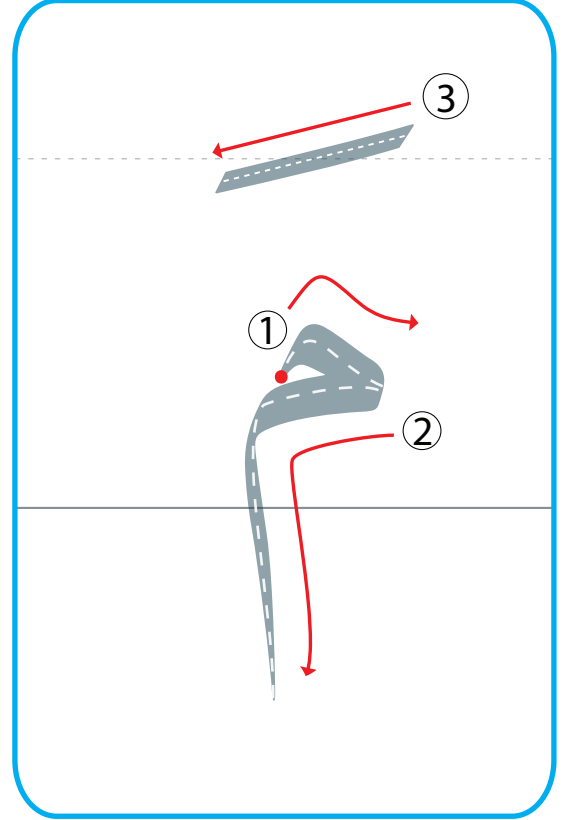

3 أَكْتُبِ الحَرْفَ بِالشَّكْلِ الصَّحِيحِ

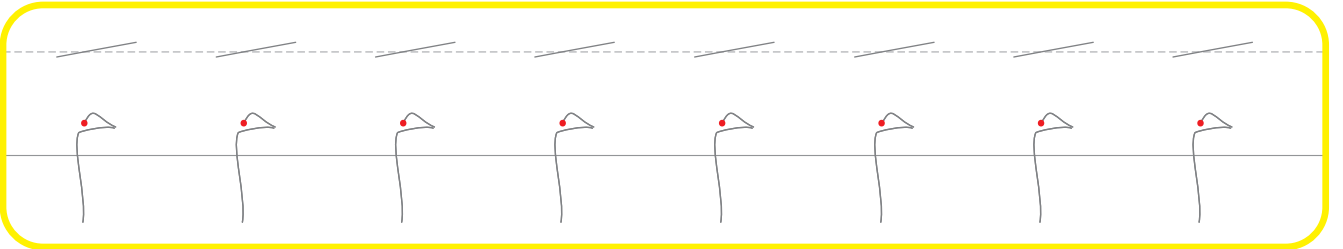
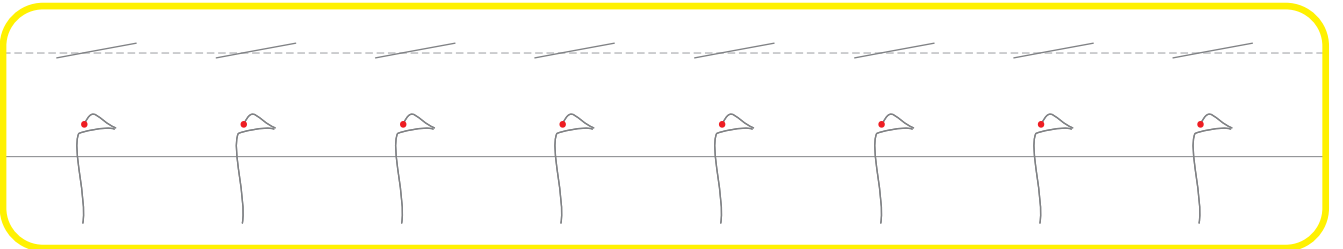



20

التَّارِيخُ:

العُمْرُ:

الاسْمُ:

2 لَوْنٌ بِالْأَلْوَانِ الْجَمِيلَةِ

1 مَرَّرِ الْقَلَمَ بِاتِّجَاهِ السَّهْمِ

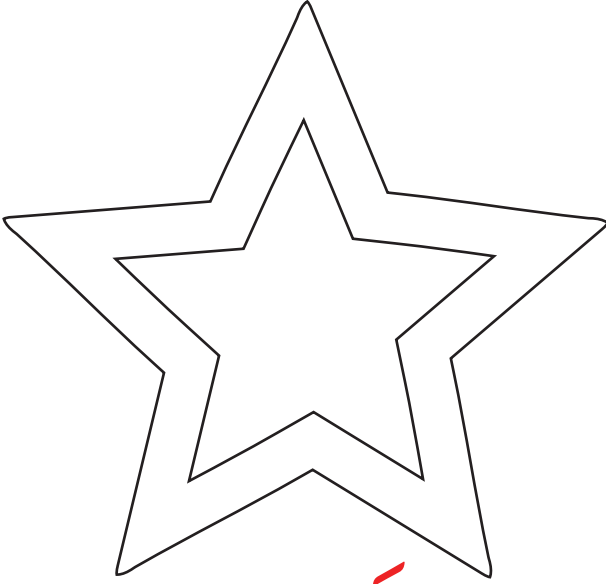

نَجْمَةٌ

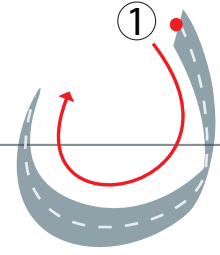
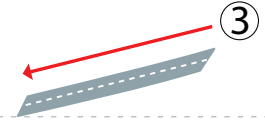

3 أَكْتُبِ الْحَرْفَ بِالشَّكْلِ الصَّحِيحِ

ن ن ن ن ن ن ن ن

ن ن ن ن ن ن ن ن

ن ن ن ن ن ن ن ن

حَرْفُ الْهَاءِ مَعَ الْفَتْحَةِ



حُرُوفِي مَعَ الْفَتْحَةِ

20

/ /

التَّارِيخُ:

العُمْرُ:

الاسْمُ:

2 لَوْنٌ بِالْأَلْوَانِ الْجَمِيلَةِ

1 مَرِّرِ الْقَلَمَ بِاتِّجَاهِ السَّهْمِ

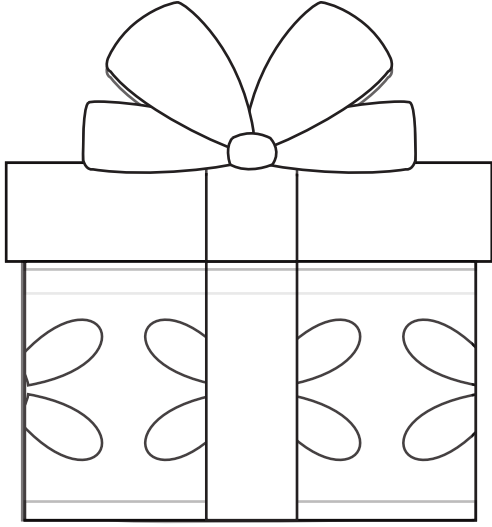

هَدِيَّةٌ

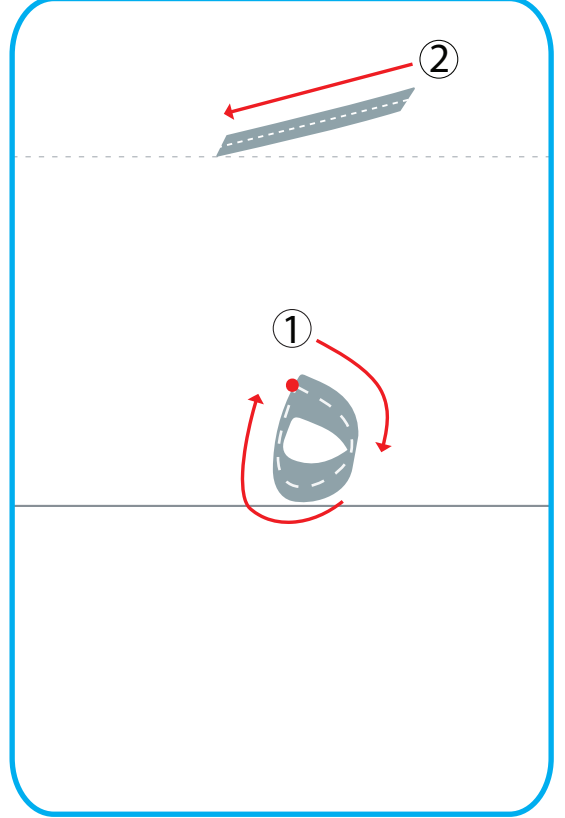

3 أَكْتُبِ الْحَرْفَ بِالشَّكْلِ الصَّحِيحِ

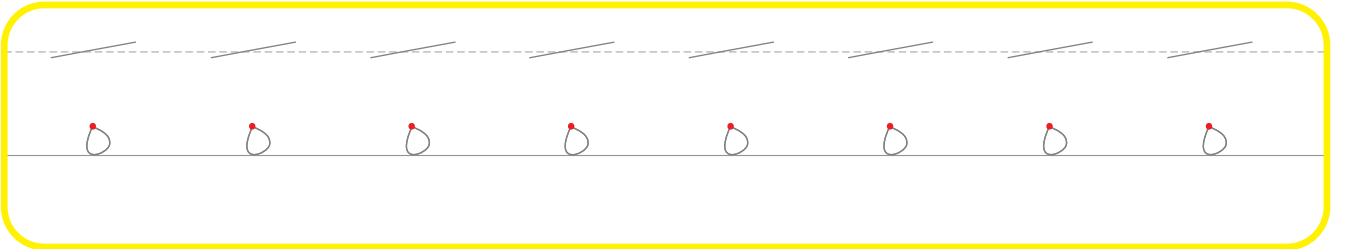
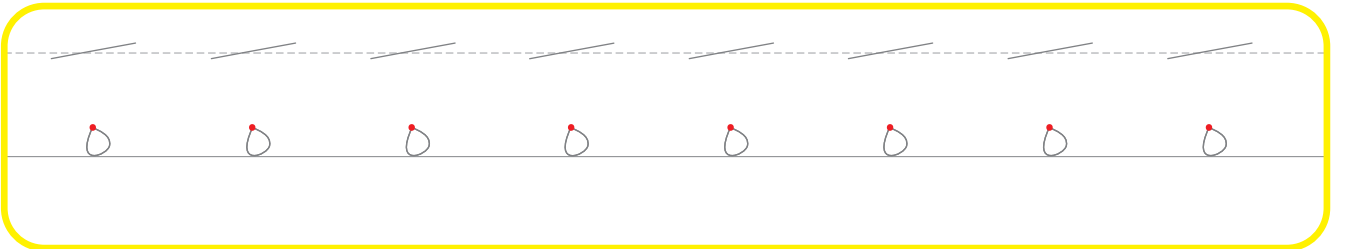



20

التَّارِيخُ:

العُمْرُ:

الاسْمُ:

2 لَوْنٌ بِالْأَلْوَانِ الْجَمِيلَةِ

1 مَرَّرِ الْقَلَمَ بِاتِّجَاهِ السَّهْمِ

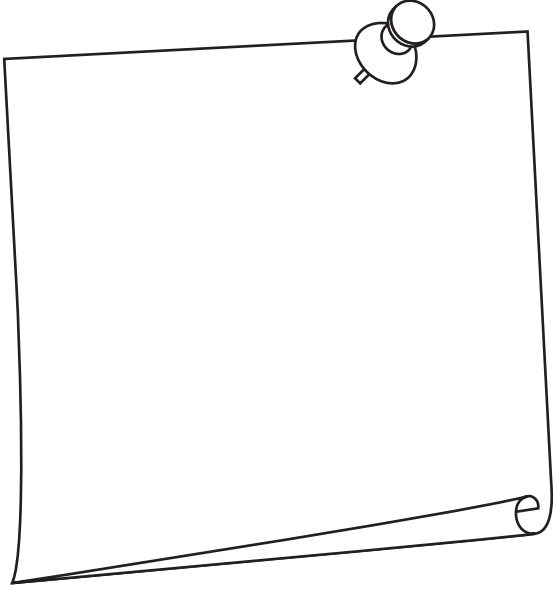

وَرَقَةٌ

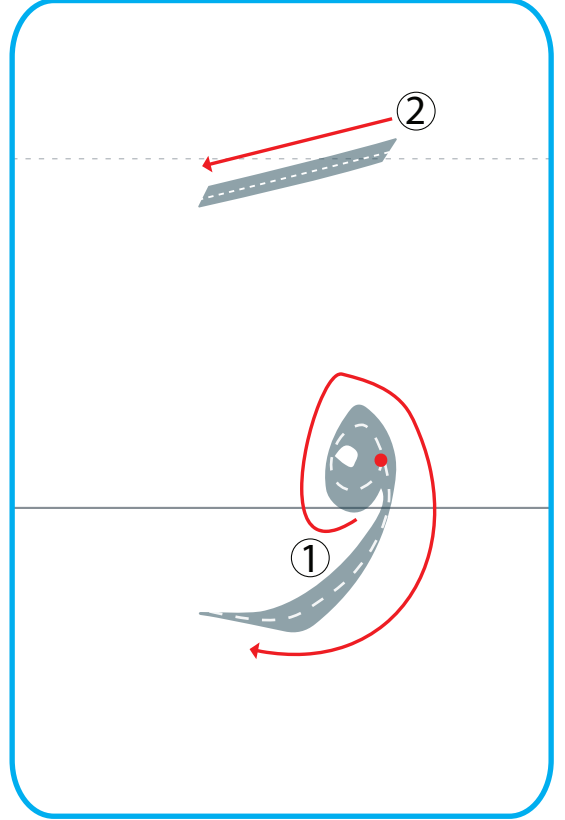

3 أَكْتُبِ الْحَرْفَ بِالشَّكْلِ الصَّحِيحِ

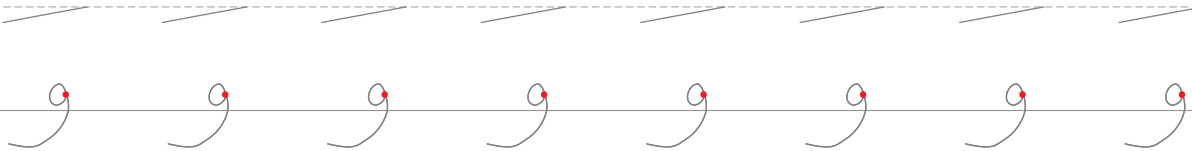
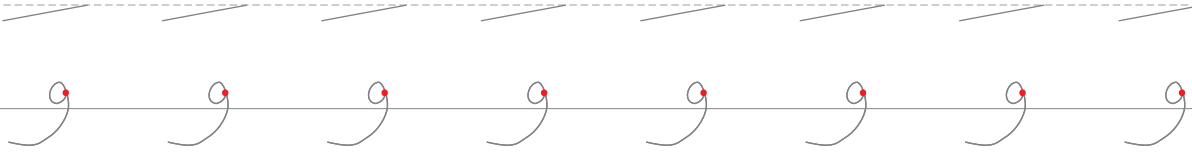



20

التَّارِيخُ:

العُمْرُ:

الاسْمُ:

2 لَوْنٌ بِالْأَلْوَانِ الْجَمِيلَةِ

1 مَرَّرِ الْقَلَمَ بِاتِّجَاهِ السَّهْمِ

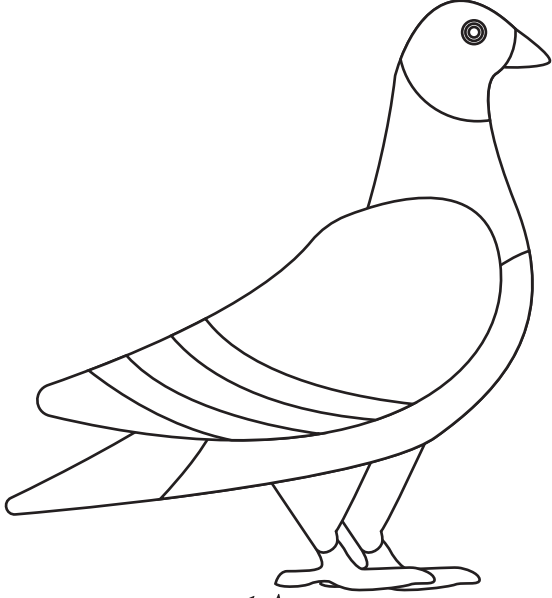

يَمَامَةٌ

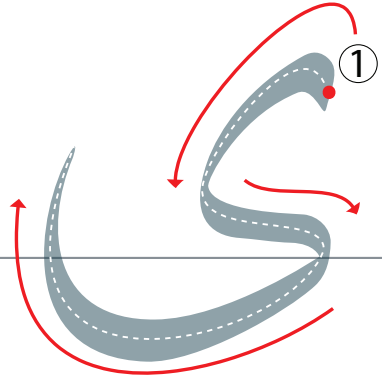
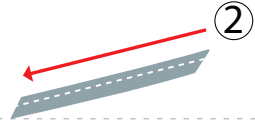

3 أَكْتُبِ الْحَرْفَ بِالشَّكْلِ الصَّحِيحِ

ي ي ي ي ي ي ي ي

ي ي ي ي ي ي ي ي

• • • • • • • •