



↓ تم تحميل ملف المادة من مكتبة طلابنا
زورونا على الموقع

www.tlabna.net

مكتبه طلابنا تقدم لكم كل ما يحتاج المعلم والمعلمه والطلبة , الطبعات الجديده للكتب والحلول ونماذج الاختبارات والتحاثير وشروحات الدروس بصيغة الورد والبي دي اف وكذلك عروض البوربوينت.

أوراق عمل

أسبوع التهيئة والاستعداد

جمع وإعداد
عبد الله السديري
@2010kaab

- أساعد مهند ليصل إلى مدرسته :

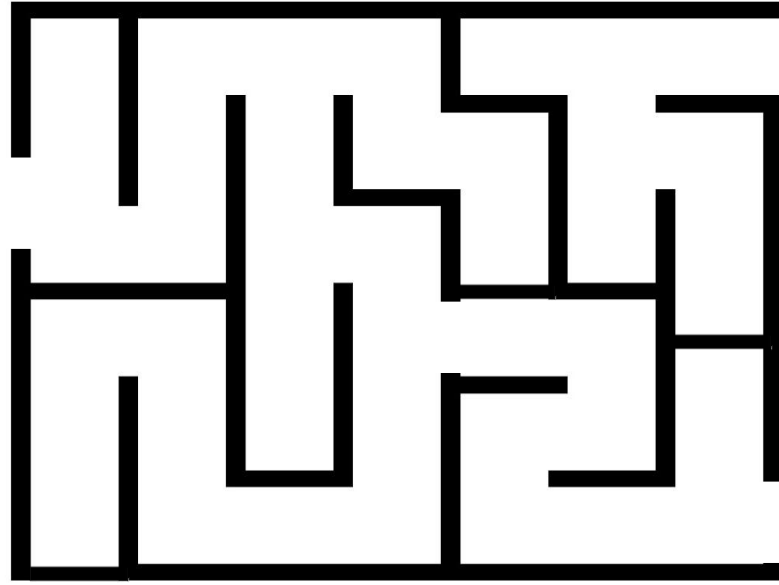

- ألون الصورتين :

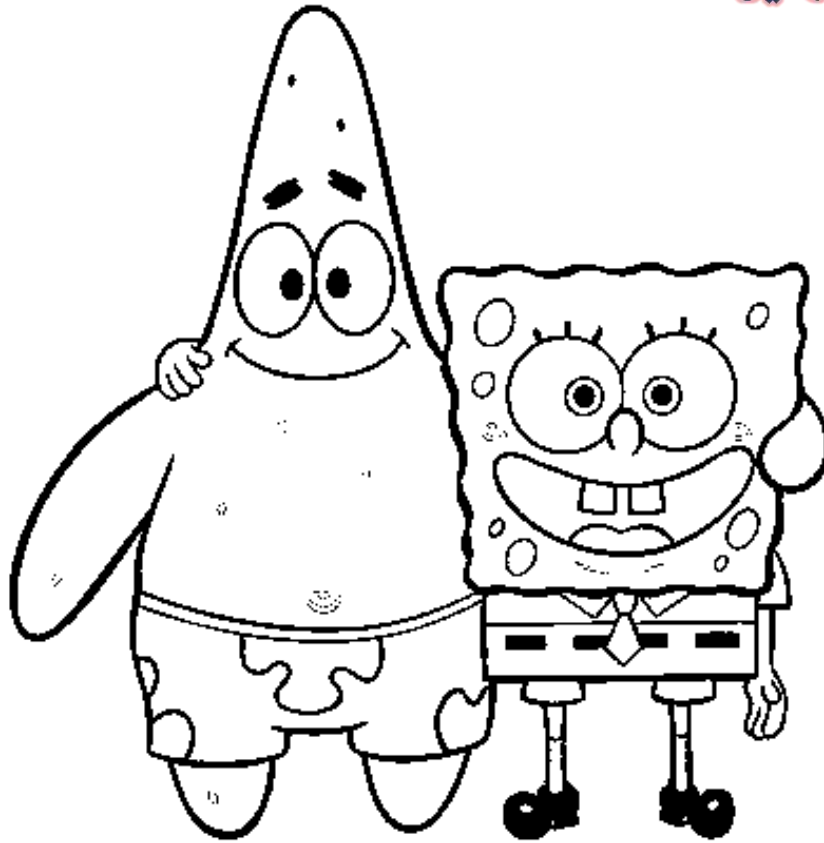

- أَمْر القلم على الخطوط الآتية :

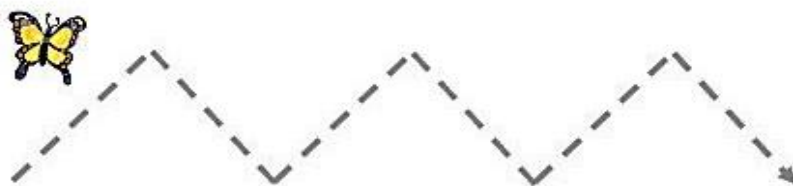
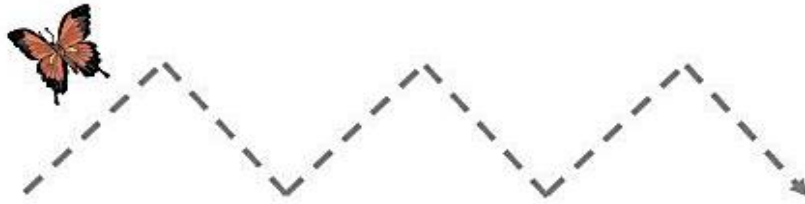
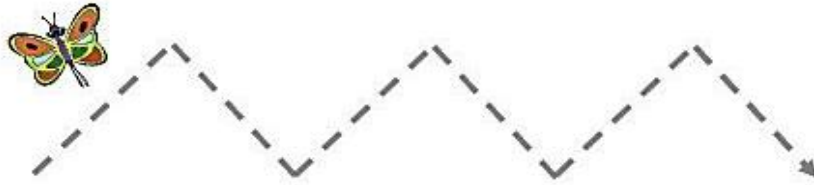
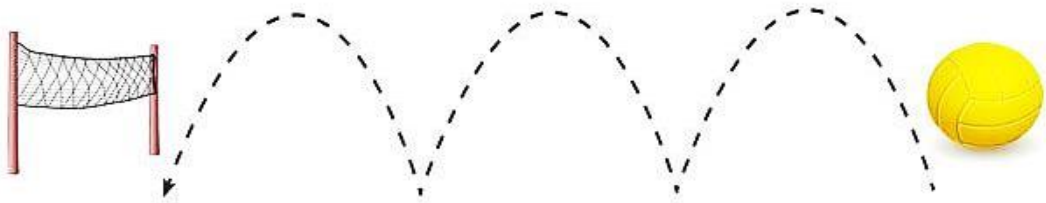
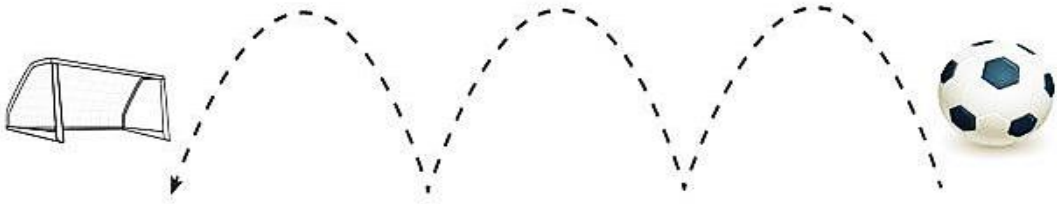
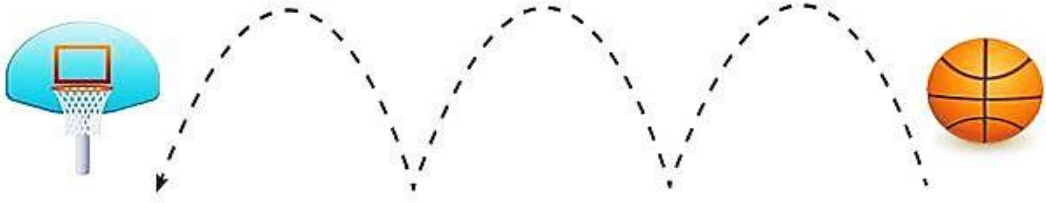

- أضع دائرة حول الأدوات المدرسية :

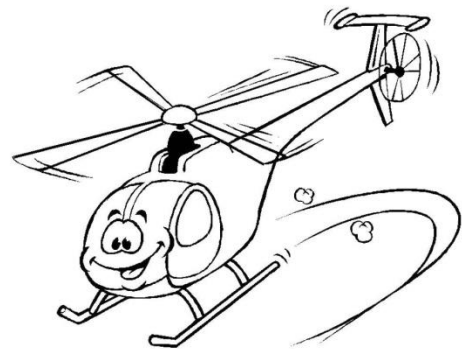
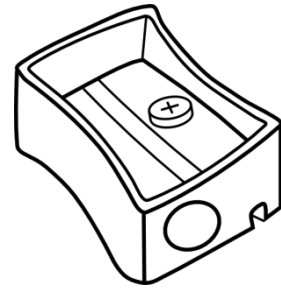
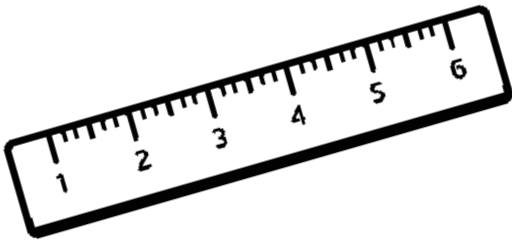
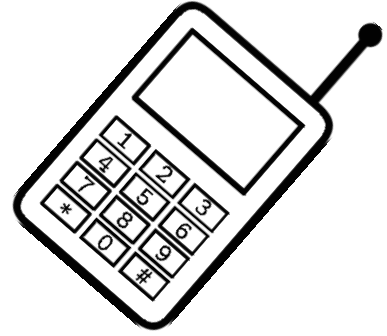
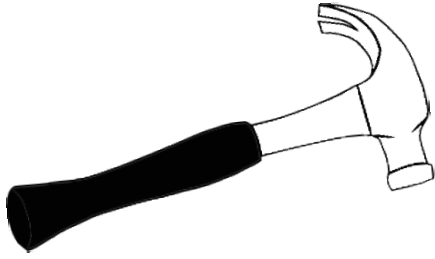
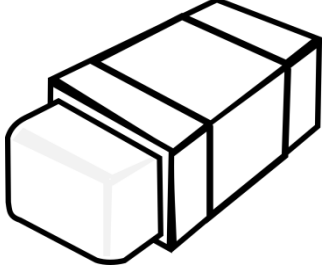

- أصل الأداة بالشئ المناسب لها :

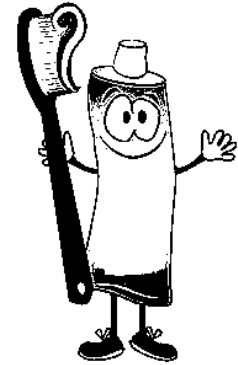
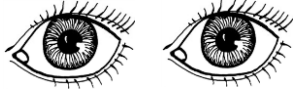

- صل كل بيت بالبيت المطابق له ، ثم ضع دائرة حول البيت
الكبير باللون الأحمر ، والبيت الصغير باللون الأزرق :

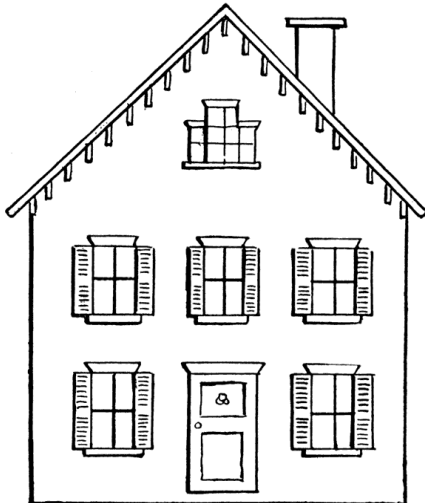
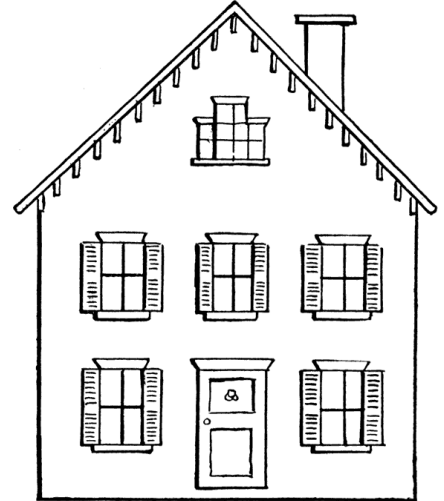
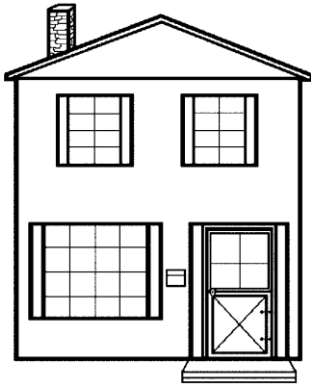

- ارسم دائرة حول أدوات الطبيب الطبية :

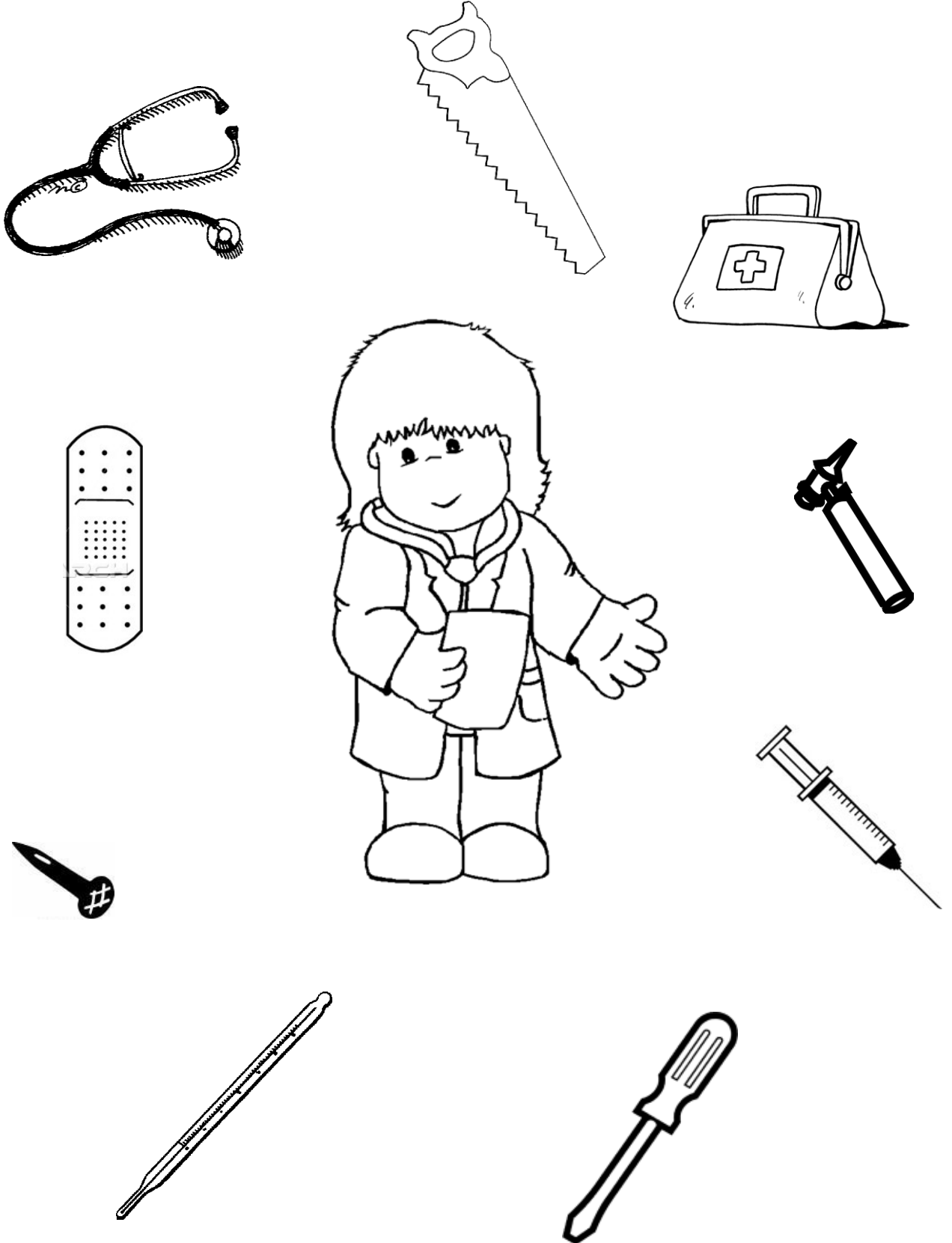

- أمر القلم على الخطوط لتكتمل صورة الزهرة ، ثم ألونها :

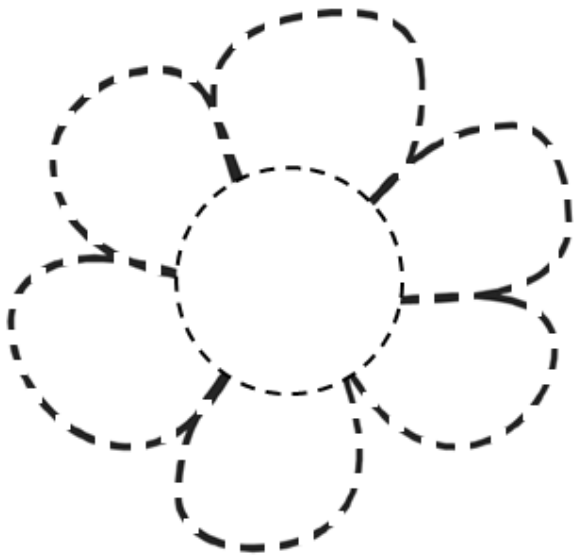
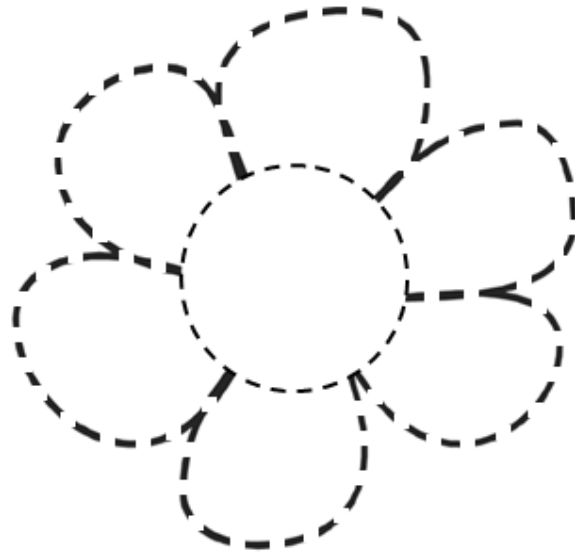
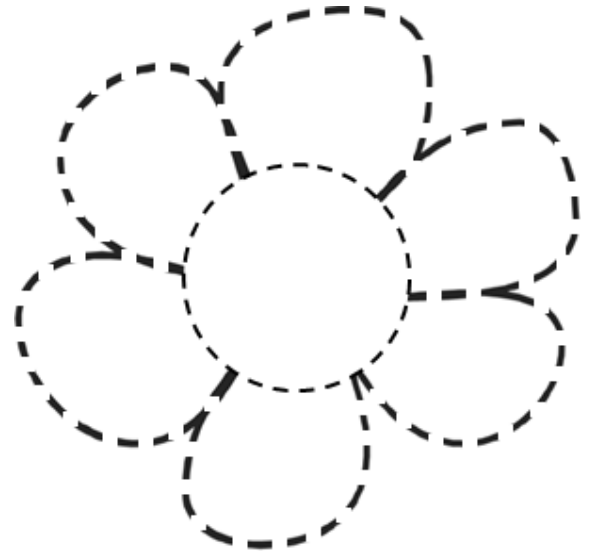
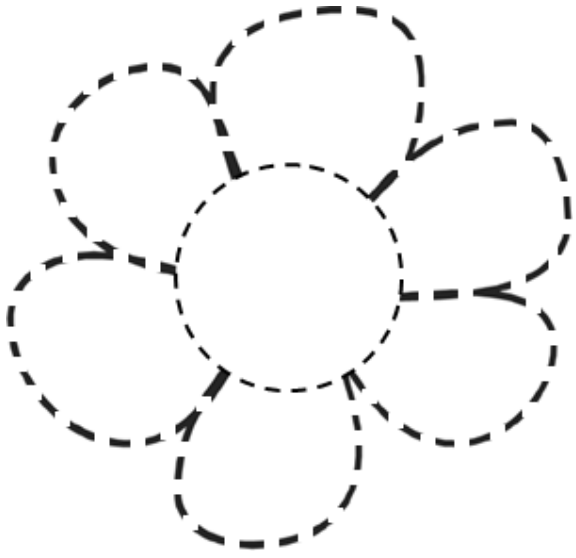

- أمر القلم على الأشكال ، وأسميها ، ثم ألون الشكل المثلث :

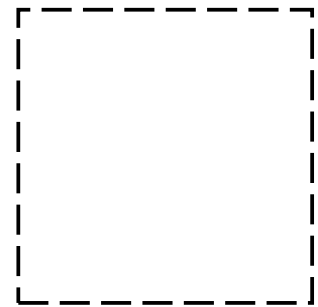
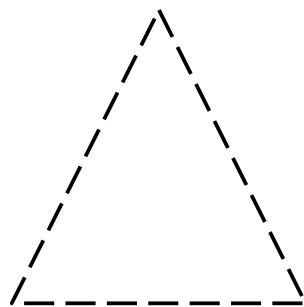
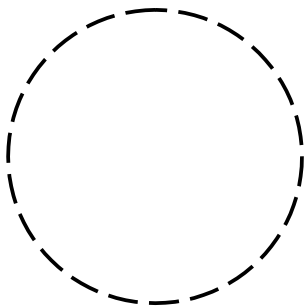
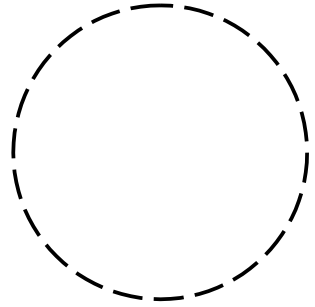
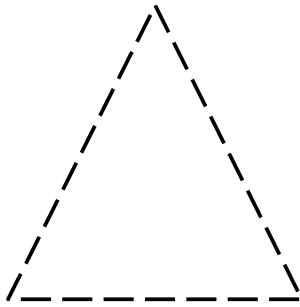
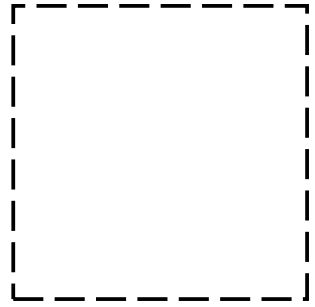
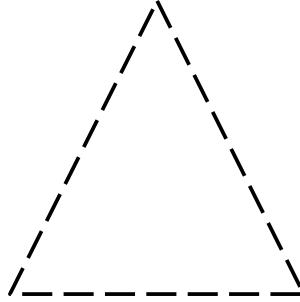
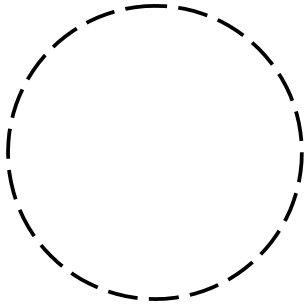
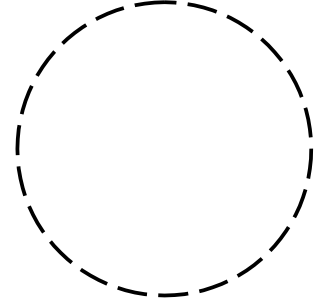
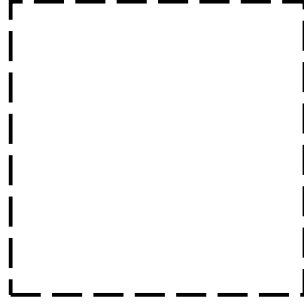
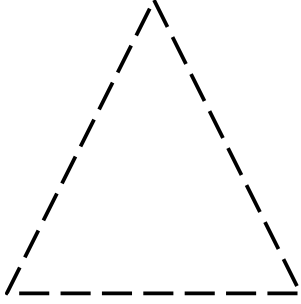

- أصل وسيلة المواصلات بالمكان المناسب لها :

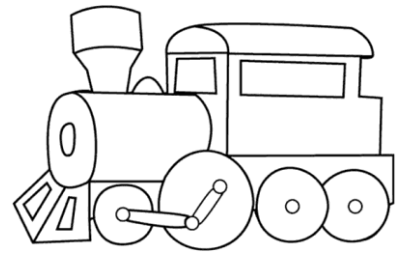
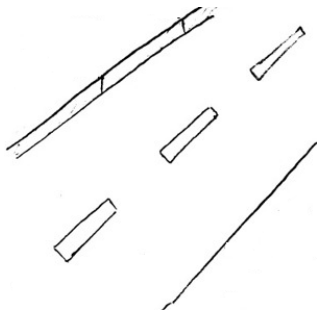
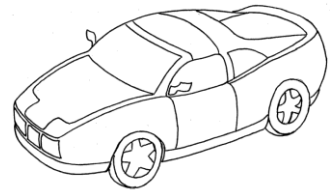
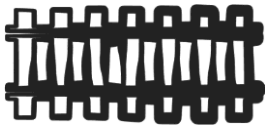
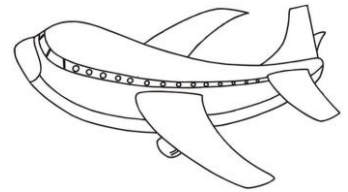
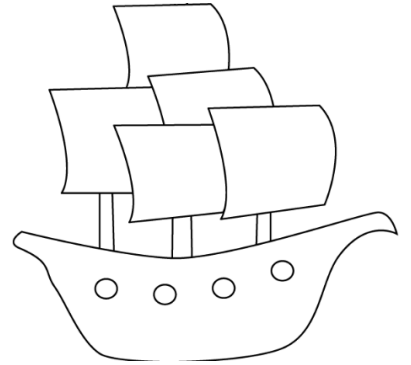

- أمر القلم على الخطوط التالية :

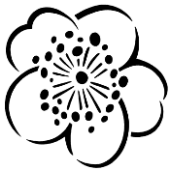
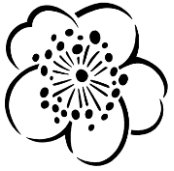
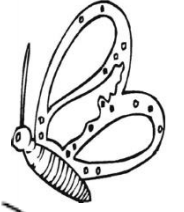
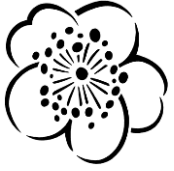
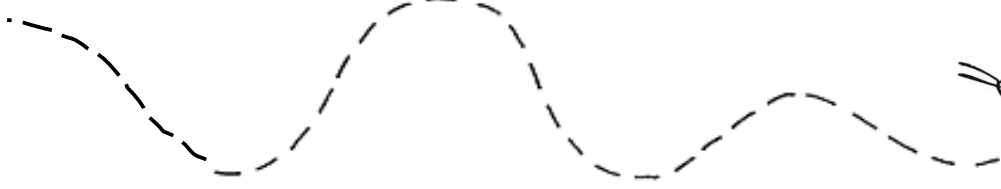
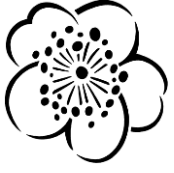

- أساعد مهند في البحث عن أدواته المدرسية، برسم دائرة حولها :

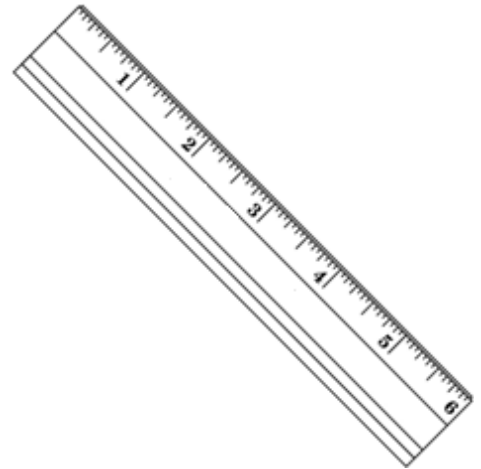
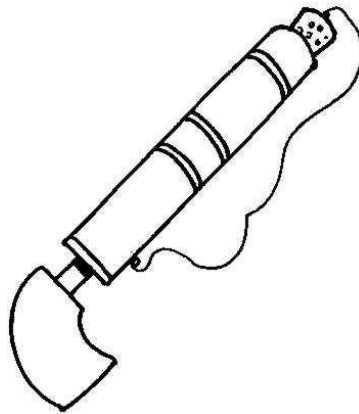
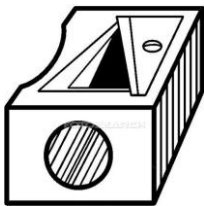
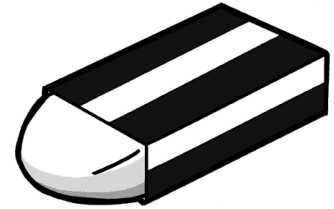
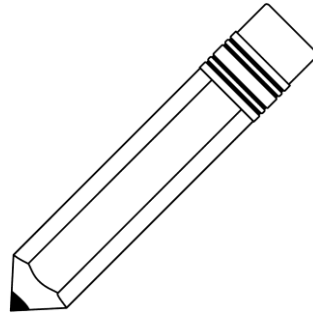
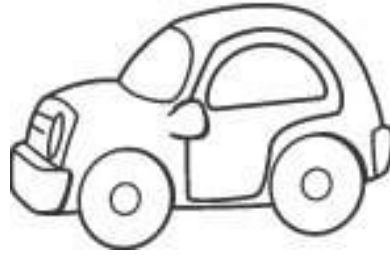

- للحيوانات فوائد عديدة ، أصل الحيوان بما نستفيد منه :

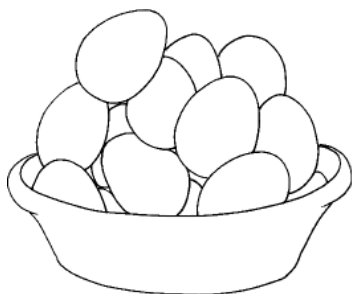
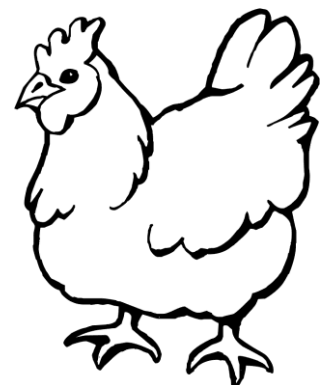
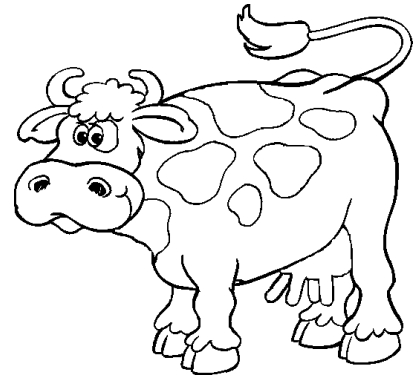
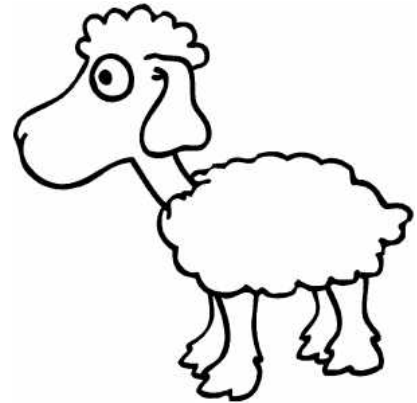
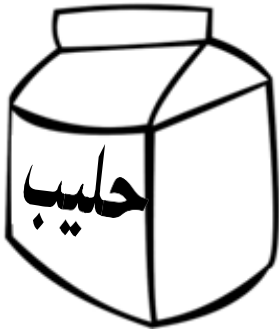

- ألون الفواكه :

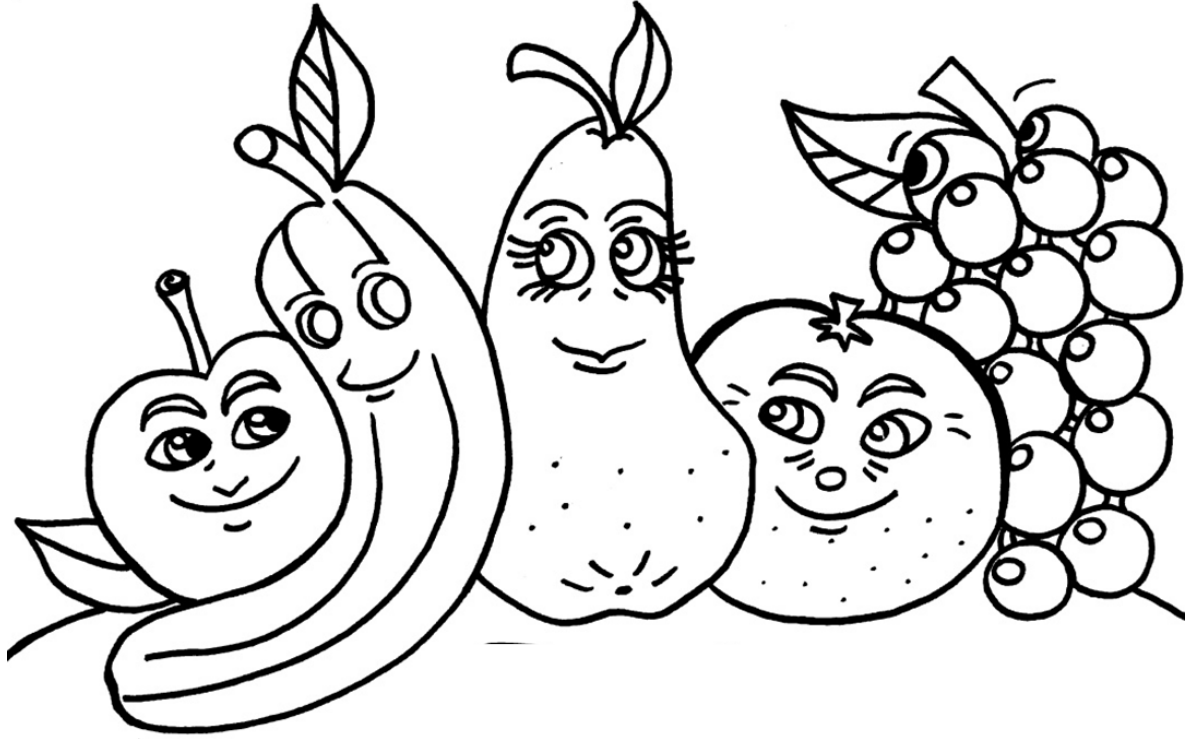

- أصل الفاكهة بنصفها الآخر :



- أرسم دائرة حول الشكل المختلف في كل مجموعة :

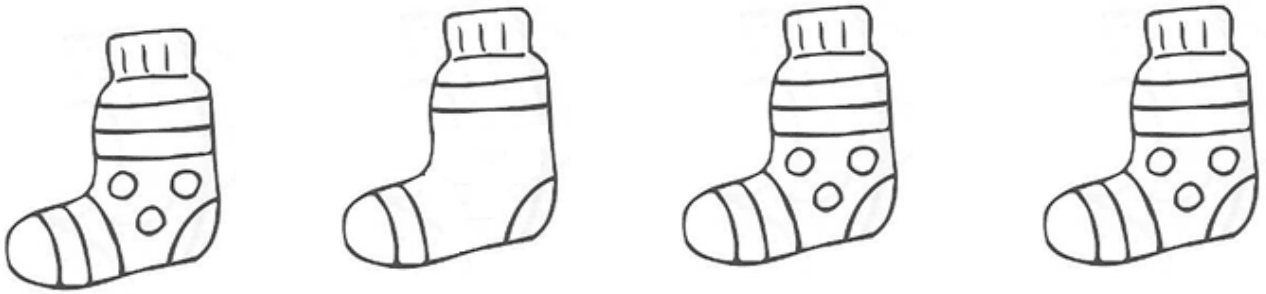
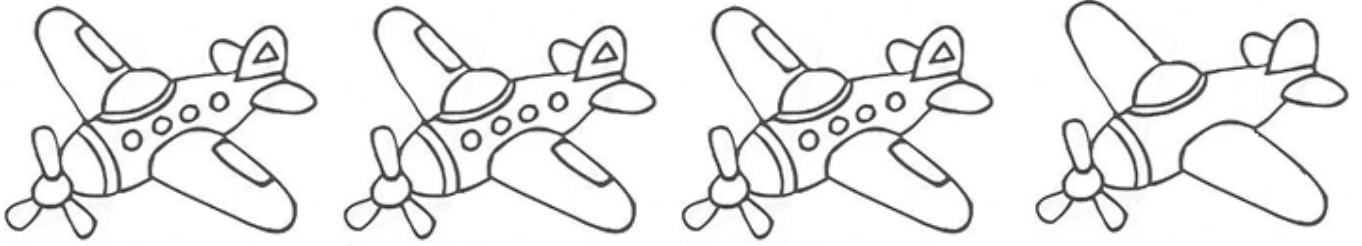

- ألون وأحاكي الصورة :

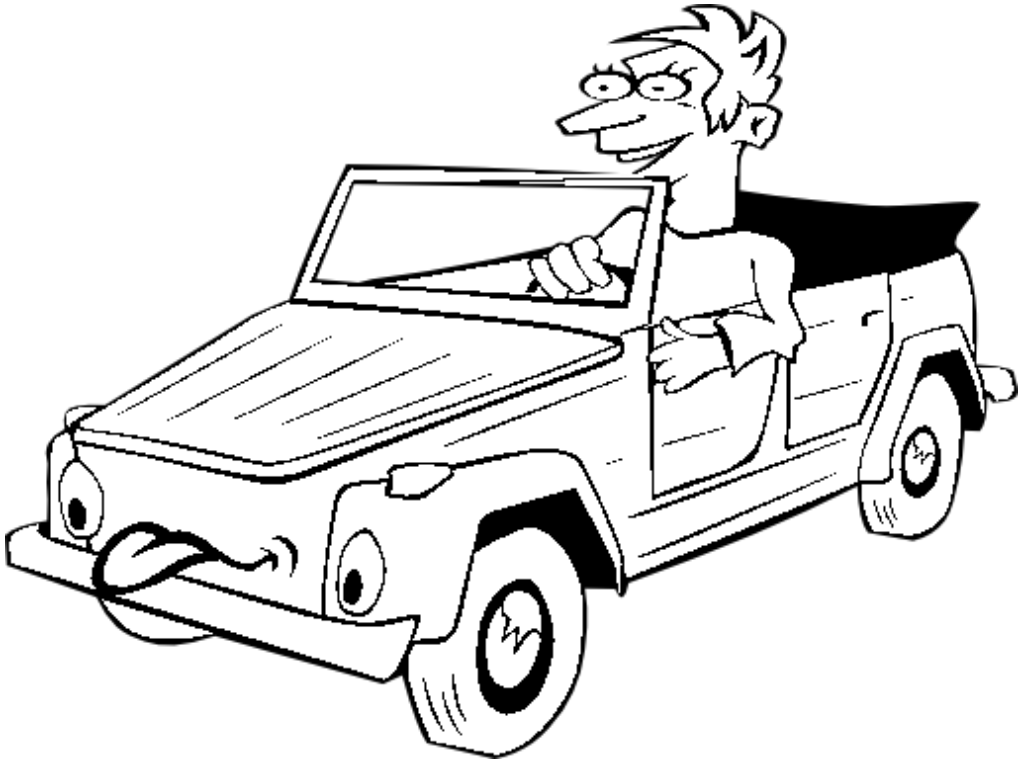

- أمر ثم ألون :

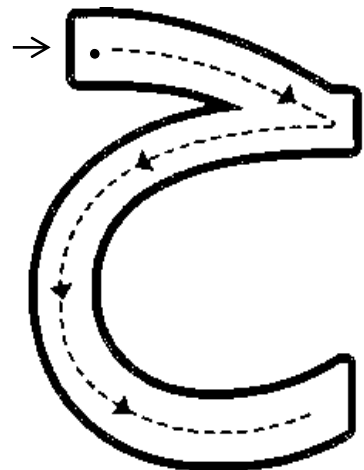
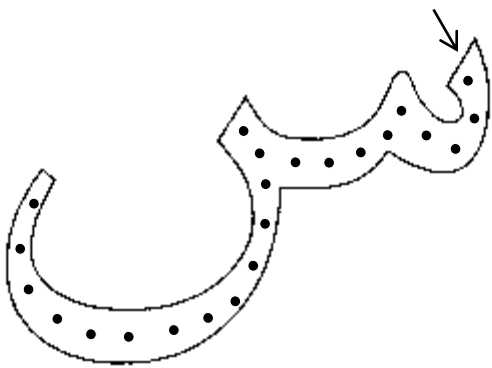
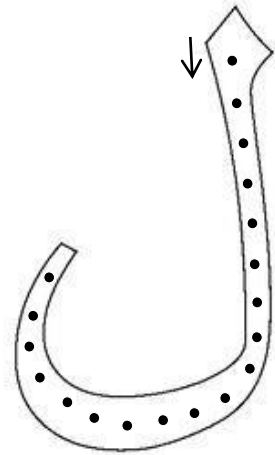
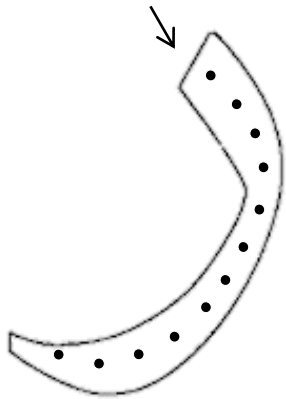
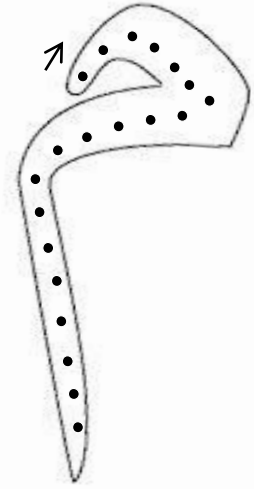
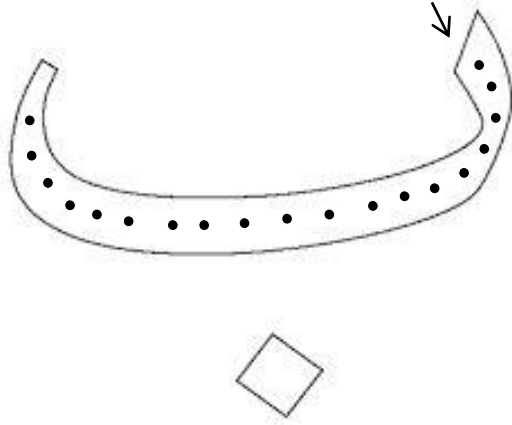

- أنا ومجموعتي نستخرج الاختلافات الموجودة في الصورتين :

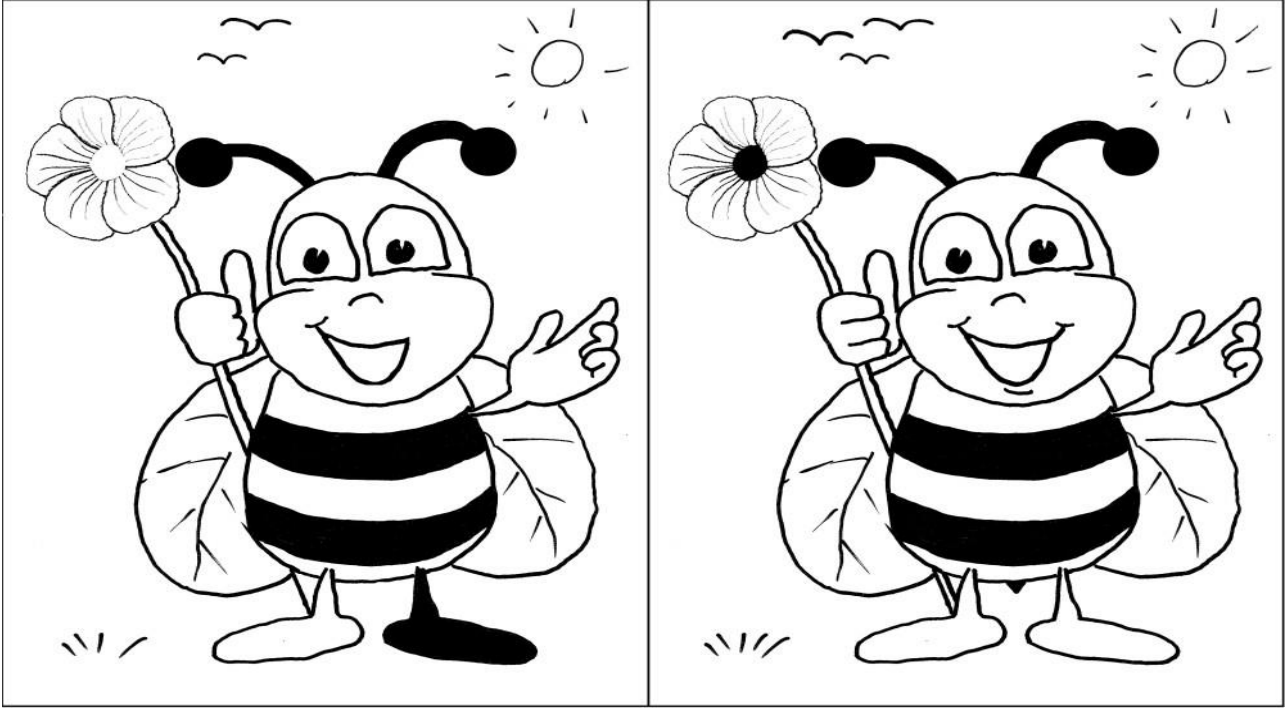

- نكمل الصورة ثم نلوونها :

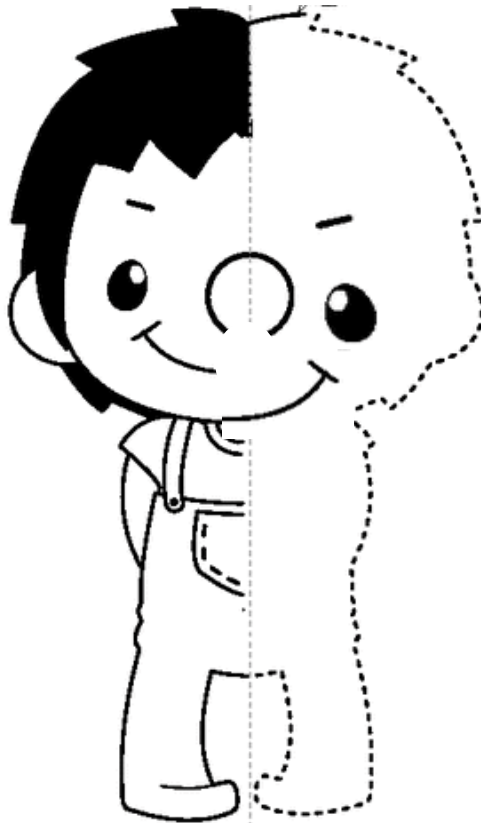

- ألون الصور :

