



↓ تم تحميل ملف المادة من مكتبة طلابنا
زورونا على الموقع

www.tlabna.net

مكتبه طلابنا تقدم لكم كل ما يحتاج المعلم والمعلمه والطلبة , الطبعات الجديده للكتب والحلول ونماذج الاختبارات والتحاظير وشروحات الدروس بصيغة الورد والبي دي اف وكذلك عروض البوربوينت.



دفتر التمارين

حروف في

اسم الطفل :

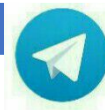

بسم الله الرحمن الرحيم

الحمد لله رب العالمين و الصلاة و السلام
على خير المرسلين ، نبينا محمد و على اله
و صحبه أجمعين .

أما بعد : فإننا نضع بين يديكم دفتر التمارين
التابع لفصل التميز ، فنسأل الله أن يبارك في الجهود و ينفع بها .

هالة مستور الحارثي

أ	ب	ت	ث	ج
ح	خ	د	ذ	ر
ز	س	ش	ط	ظ
ط	ظ	ع	ف	ق
ق	ك	ل	م	ن
ن	هـ	و	ي	

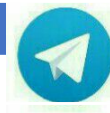

استخدم الصلصال في رسم الحرف :

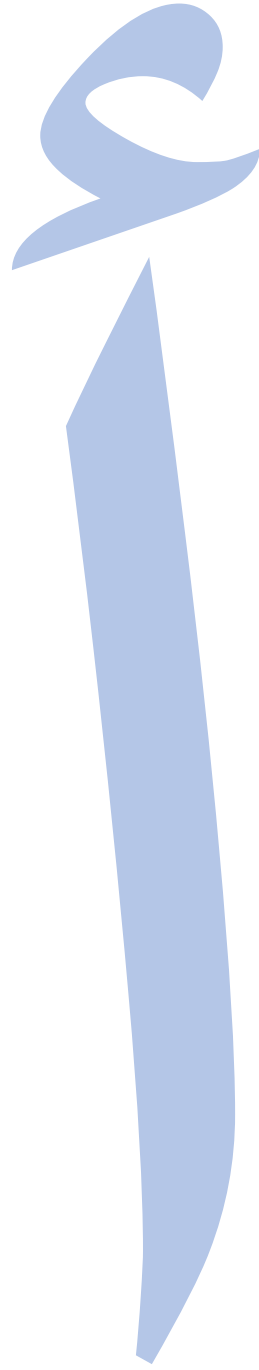

أ



أرنب





ا



ا



ا

قم بتلوين الرسمة التالية :

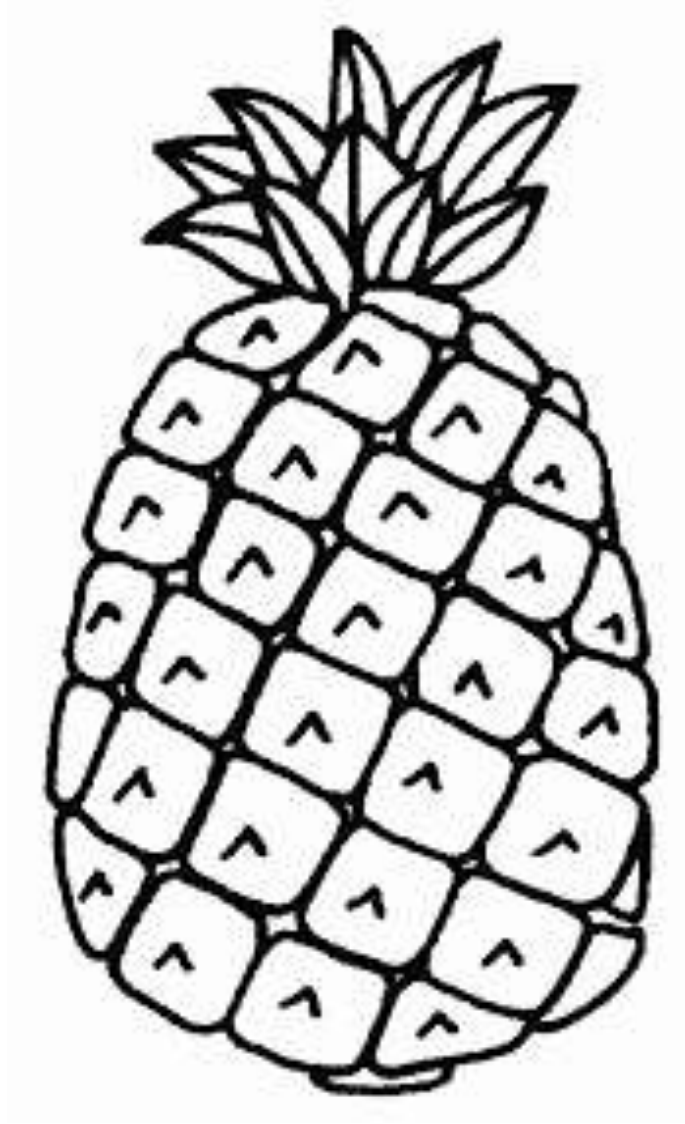

أناناس



استخدم الصلصال في رسم الحرف :



ب



بطة





ج



ج



ج

قم بتلوين الرسمة التالية :

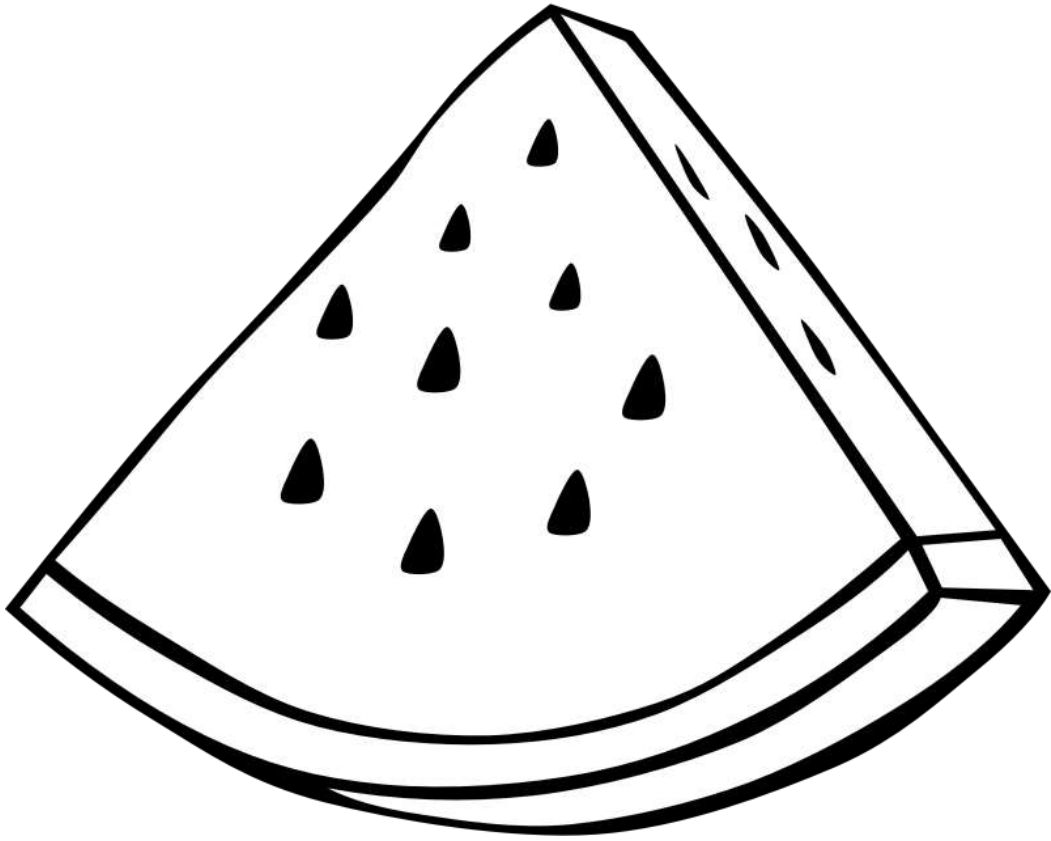

بطيخ

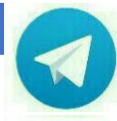

استخدم الصلصال في رسم الحرف :

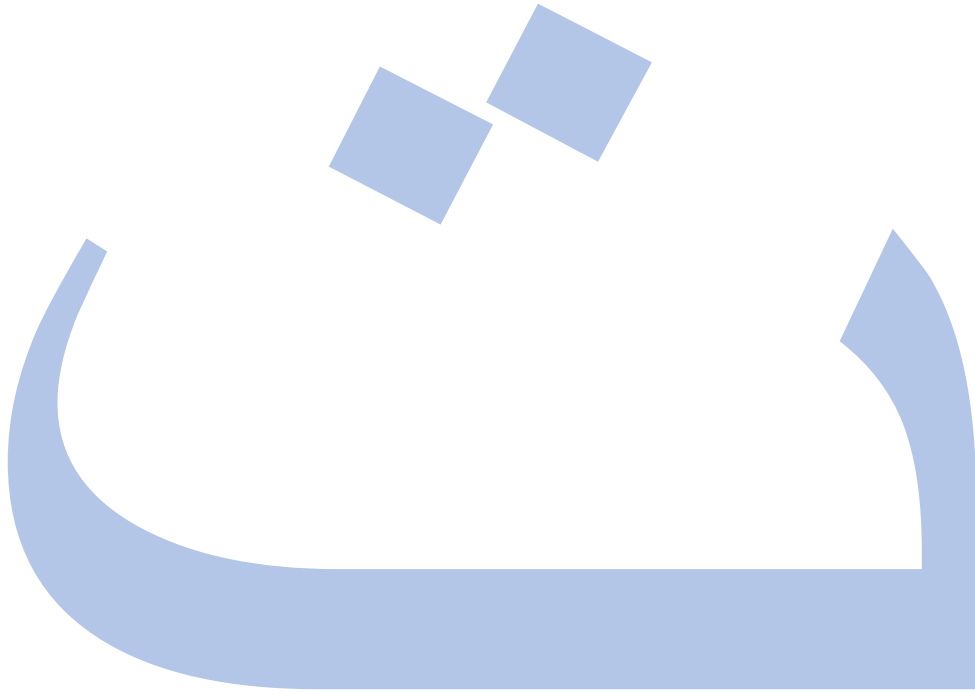

ث



تفاحة





ت



ث



د

قم بتلوين الرسمة التالية :

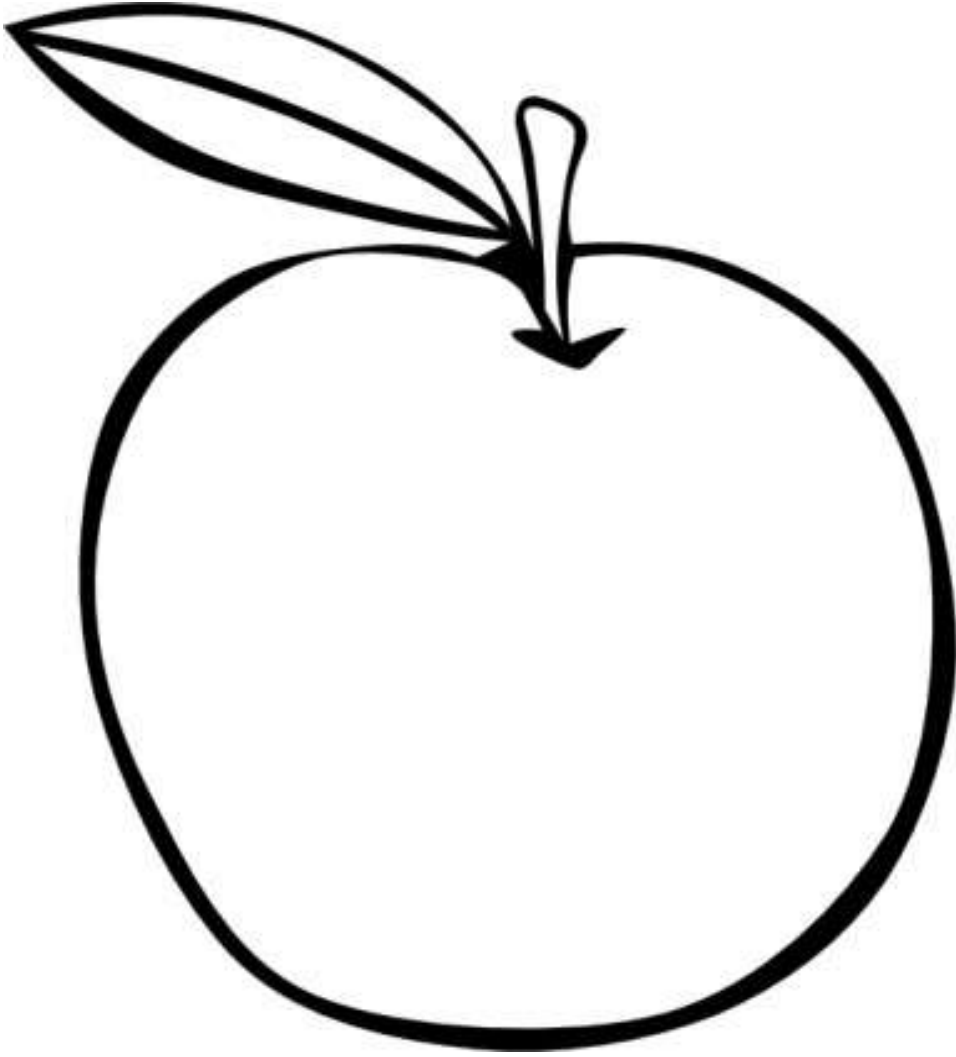

تفاح



استخدم الصلصال في رسم الحرف :

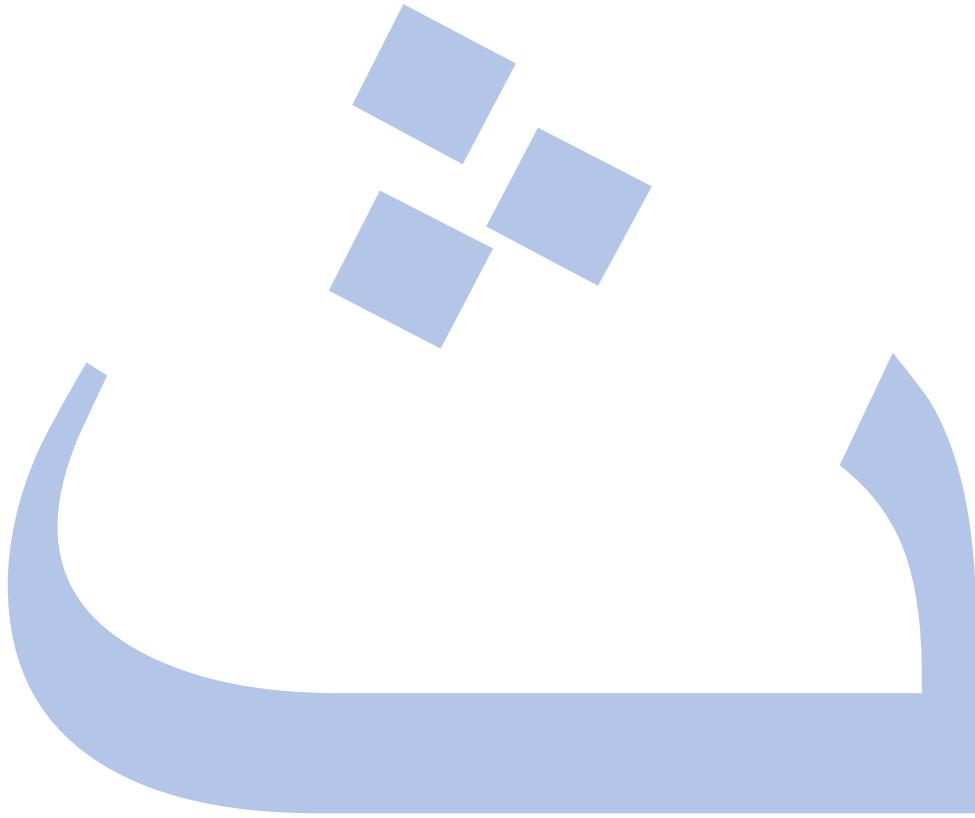

ث



ثعبان

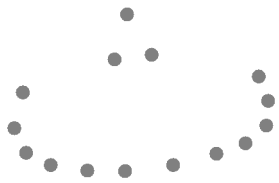



ت



ت



ت

قم بتلوين الرسمة التالية :

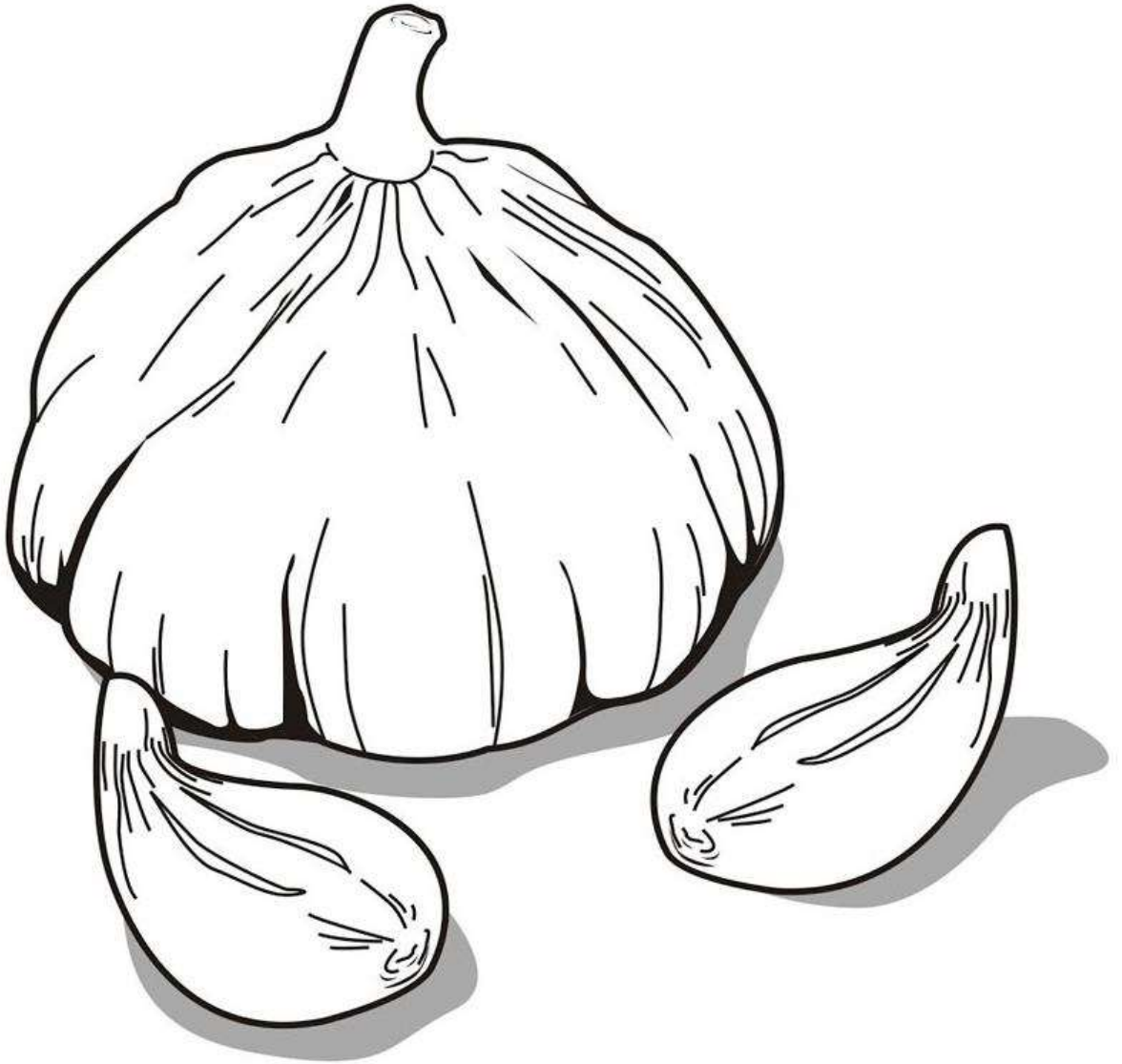

توم

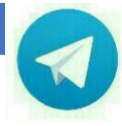

استخدم الصلصال في رسم الحرف :



ج



جزر

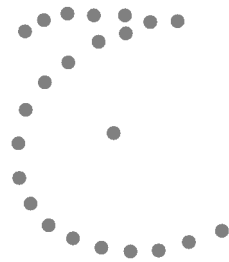
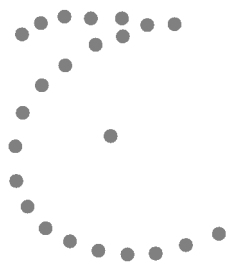
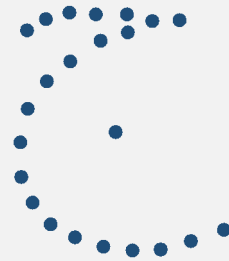
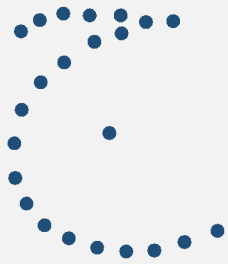



ج



ح



خ

قم بتلوين الرسمة التالية :



جزر

استخدم الصلصال في رسم الحرف :



ح



حليب

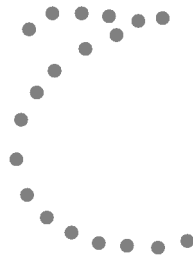
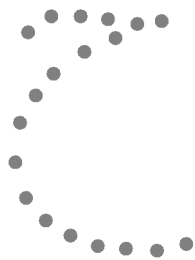



ع



ع



ع

قم بتلوين الرسمة التالية :



حقيقية



استخدم الصلصال في رسم الحرف :



خ



خبز

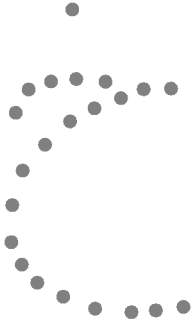
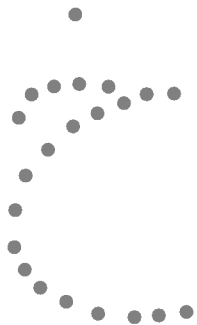



ح



خ



ح

قم بتلوين الرسمة التالية :



خس



استخدم الصلصال في رسم الحرف :



ح



ب





ا



ا



ا

قم بتلوين الرسمة التالية :

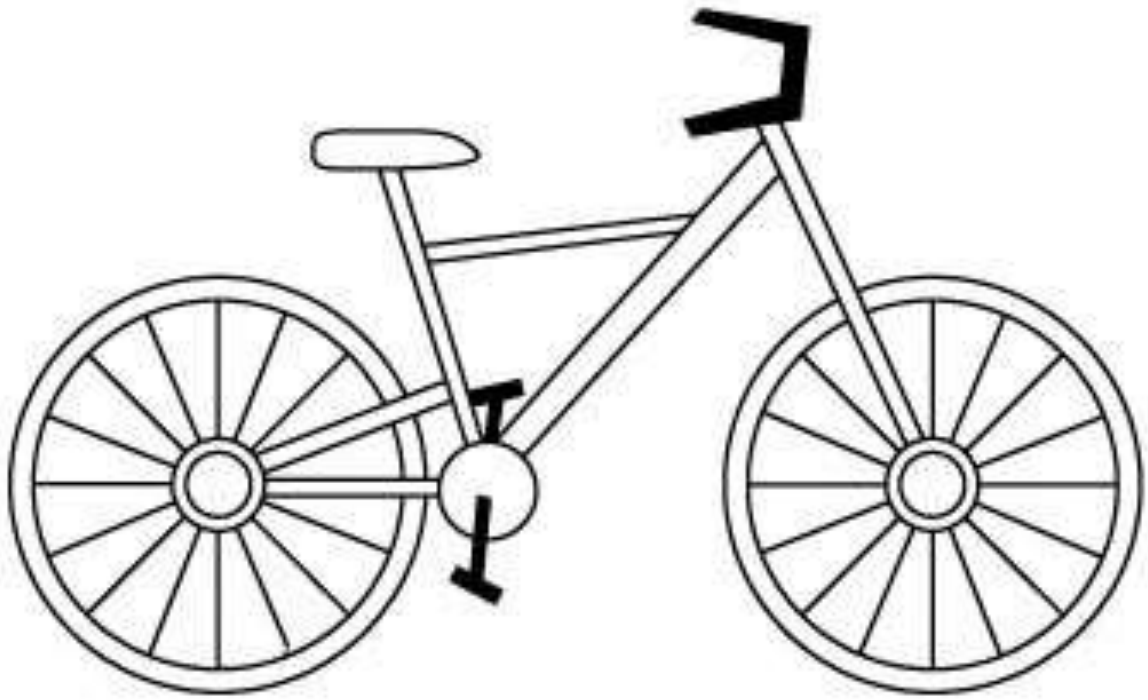

دراجة

استخدم الصلصال في رسم الحرف :



ذ



ذئب





ا



أ



إ

قم بتلوين الرسمة التالية :

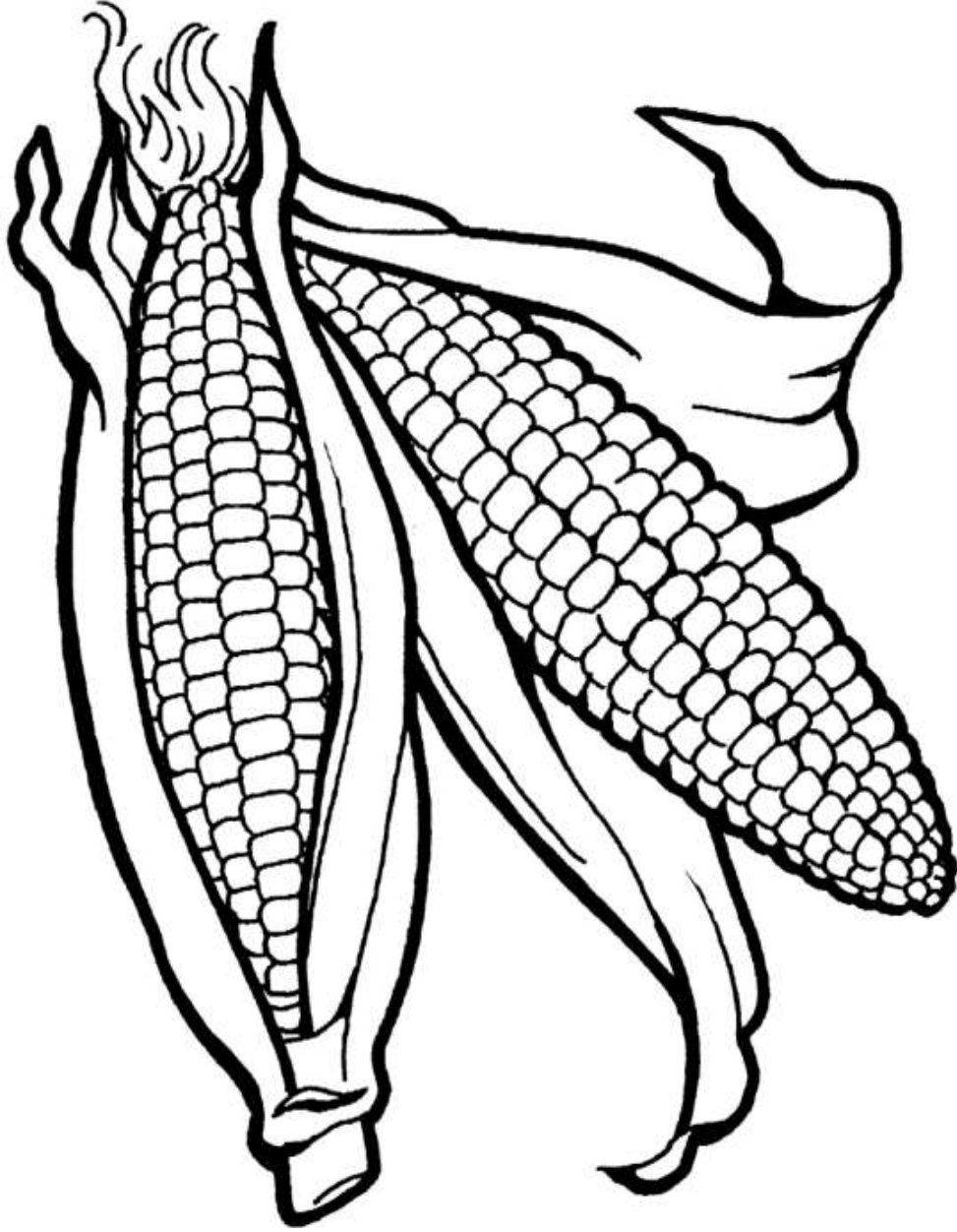

ف



استخدم الصلصال في رسم الحرف :





رمان



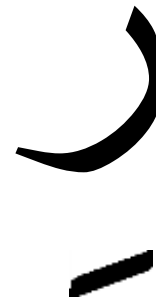

قم بتلوين الرسمة التالية :

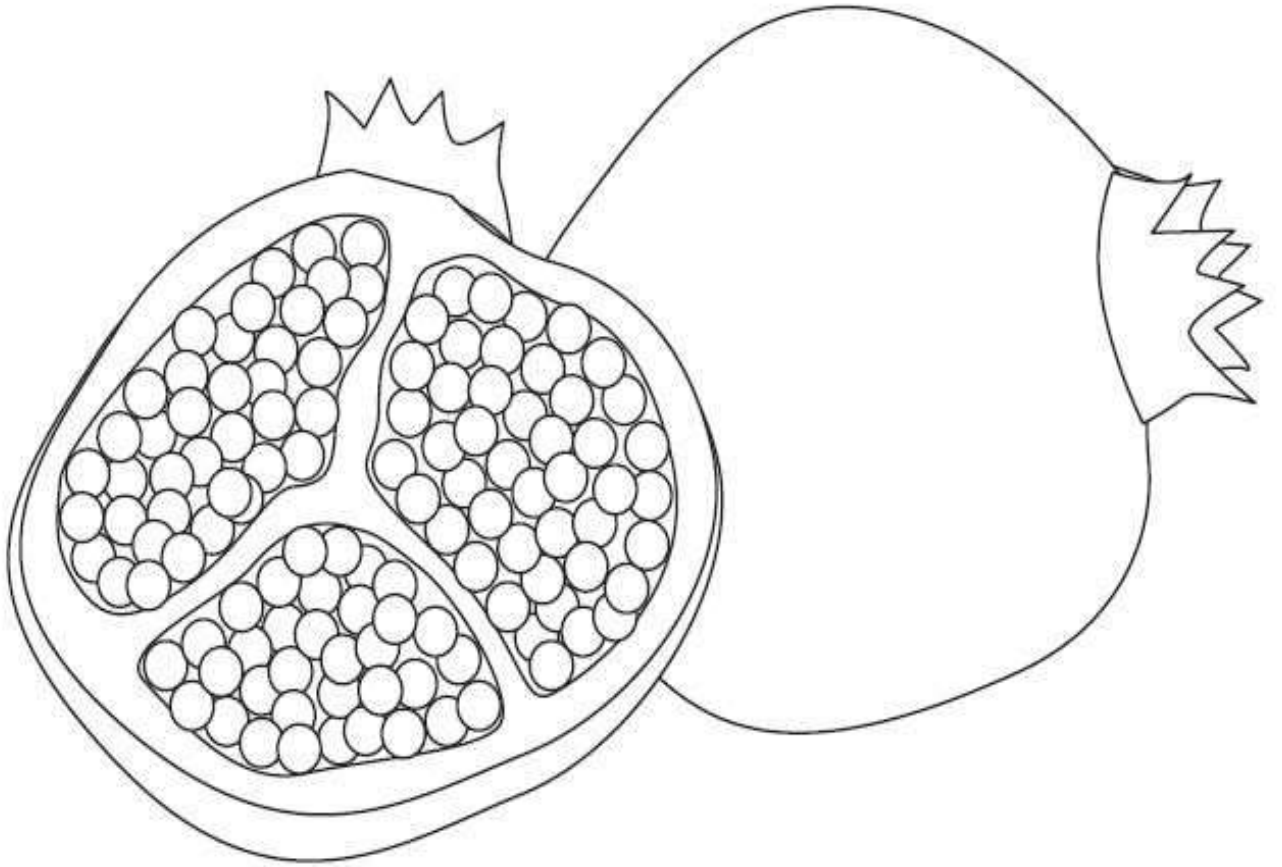

رمان

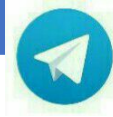

استخدم الصلصال في رسم الحرف :



ز



زهرة





اين



نرا



ممن

قم بتلوين الرسمة التالية :

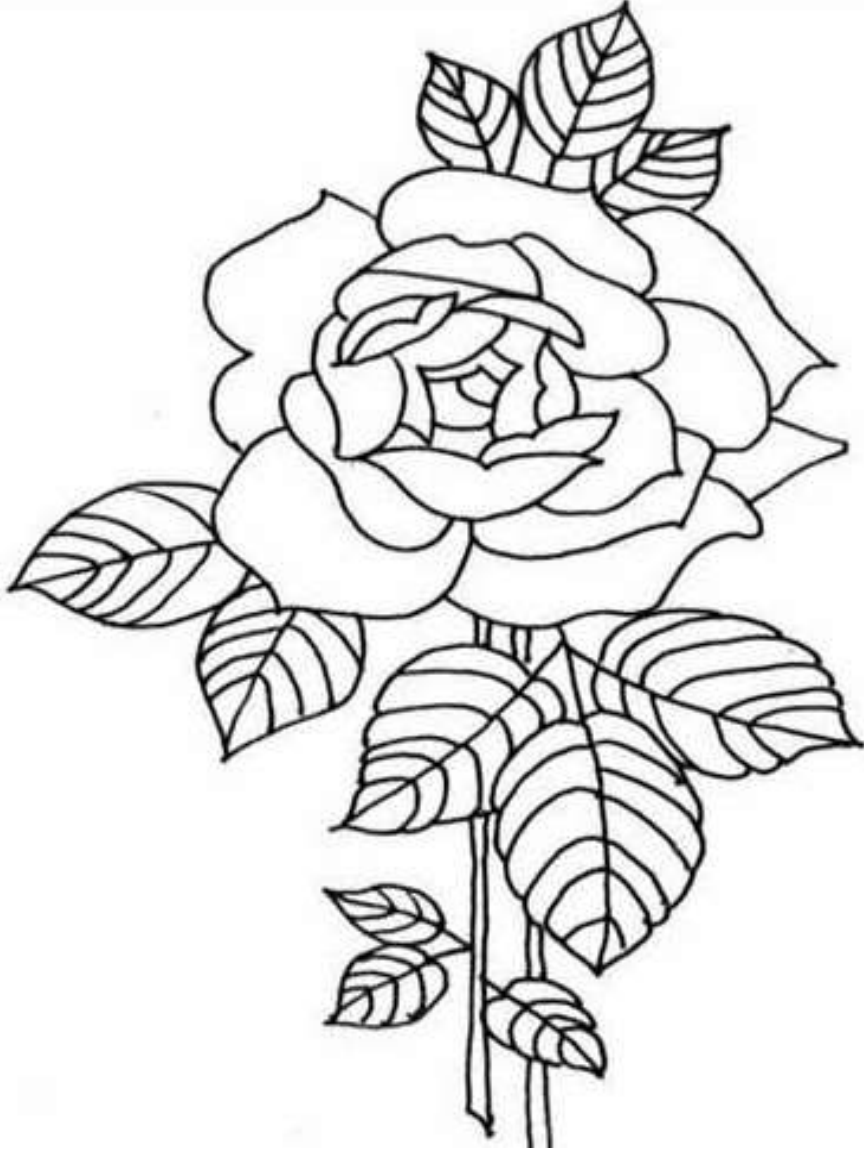

زفورة



استخدم الصلصال في رسم الحرف :



س



سمكة

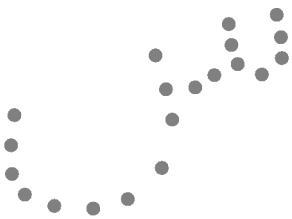



ا
س



س
ا



و
س

قم بتلوين الرسمة التالية :

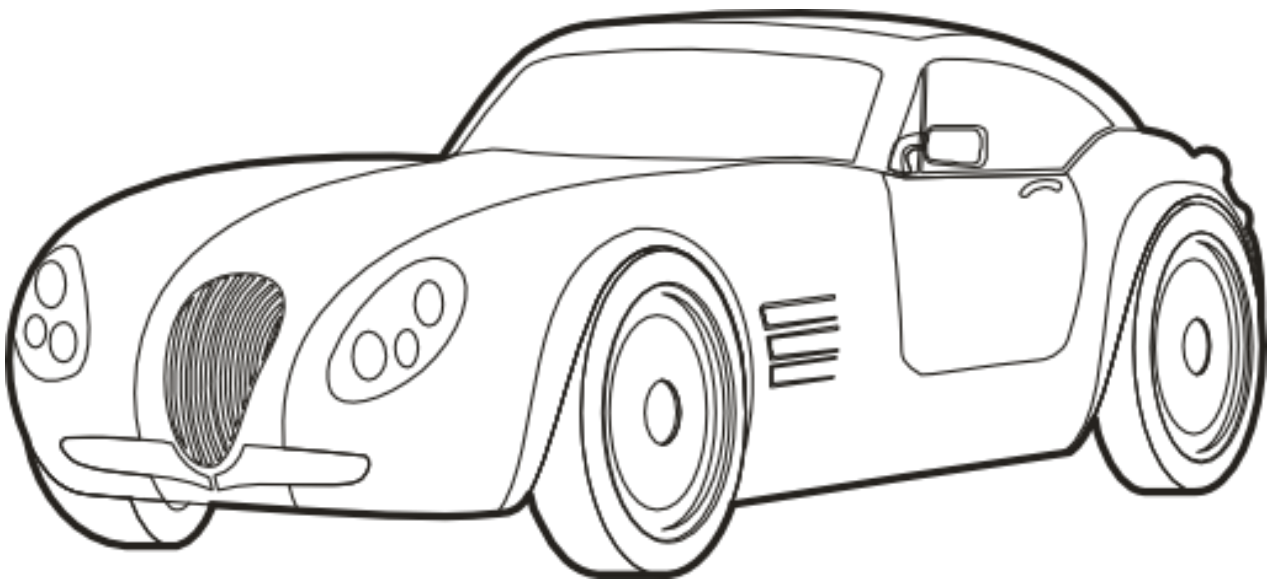

سيارة

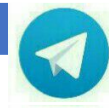

استخدم الصلصال في رسم الحرف :



ش



شمس

ش

ش

ش

ش

ش

ش



ا



آ



أ

قم بتلوين الرسمة التالية :

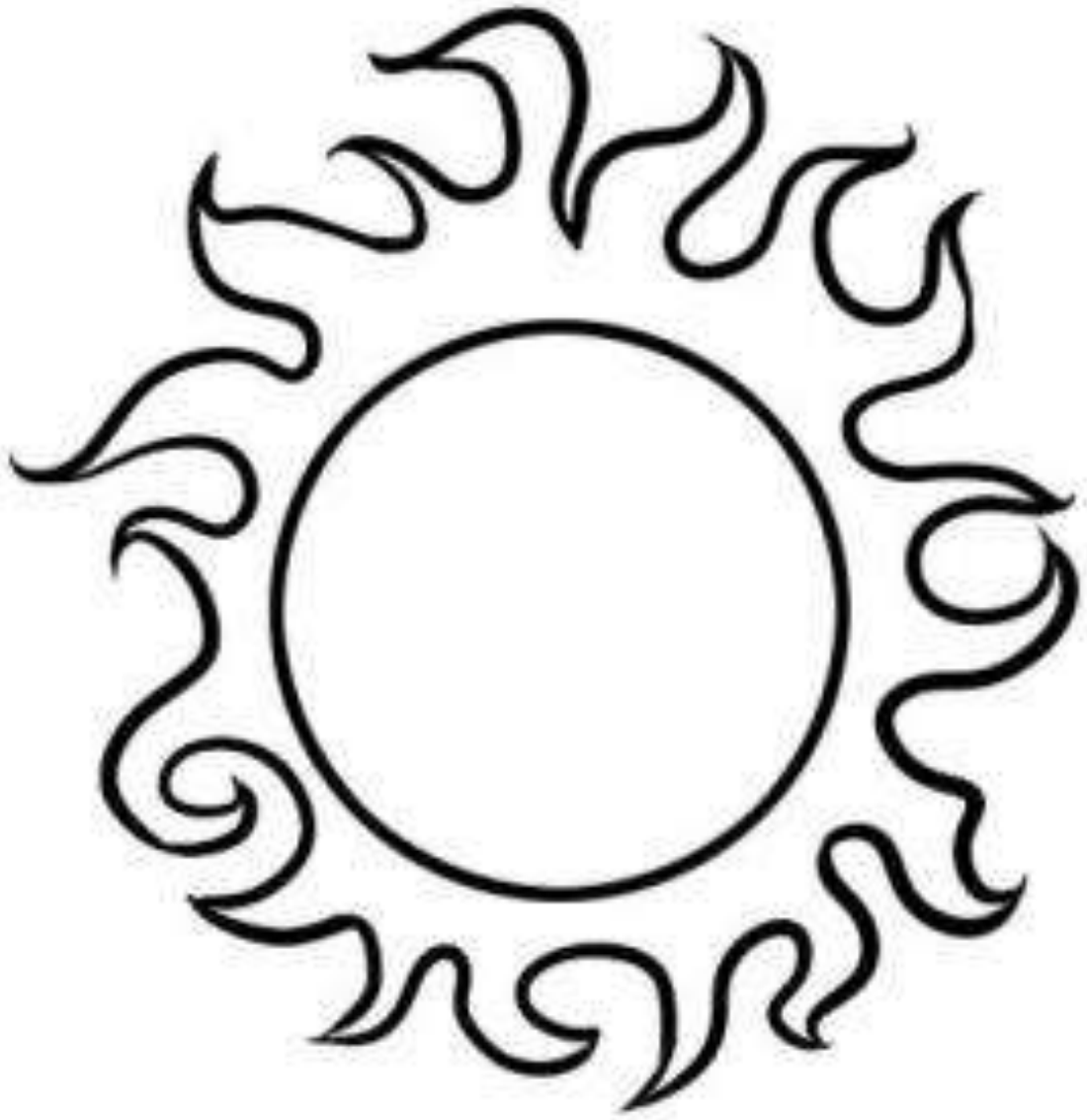

شمس

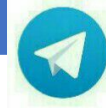

استخدم الصلصال في رسم الحرف :

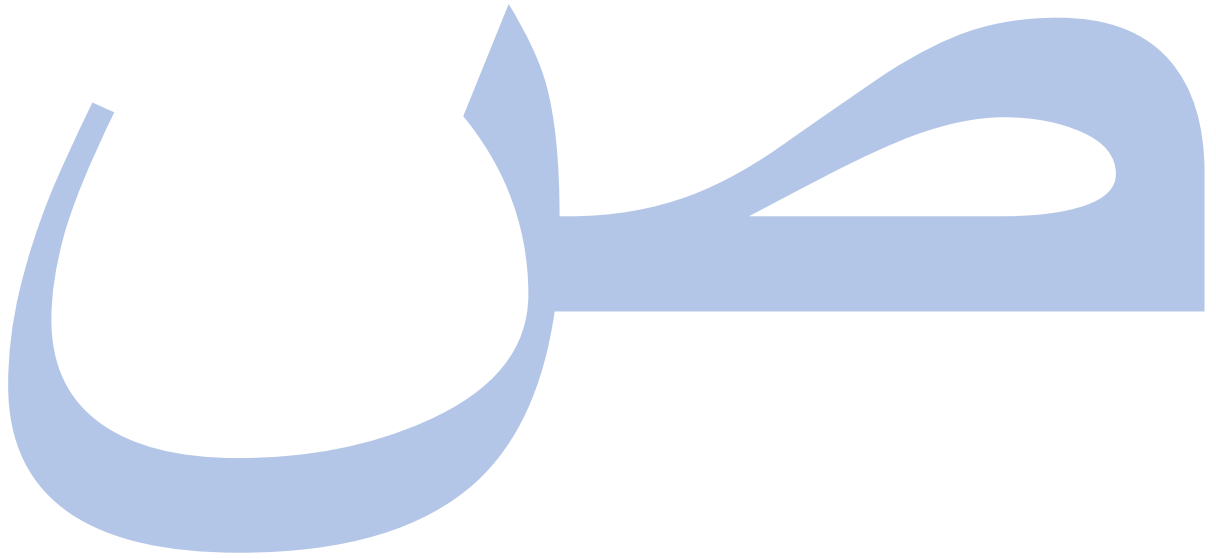

ص



صحن

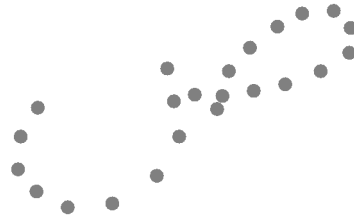
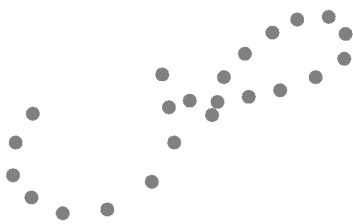
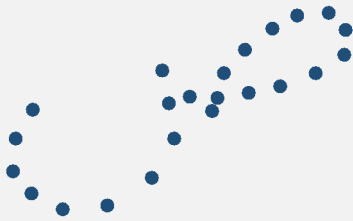



ط



ظ



ظ

قم بتلوين الرسمة التالية :

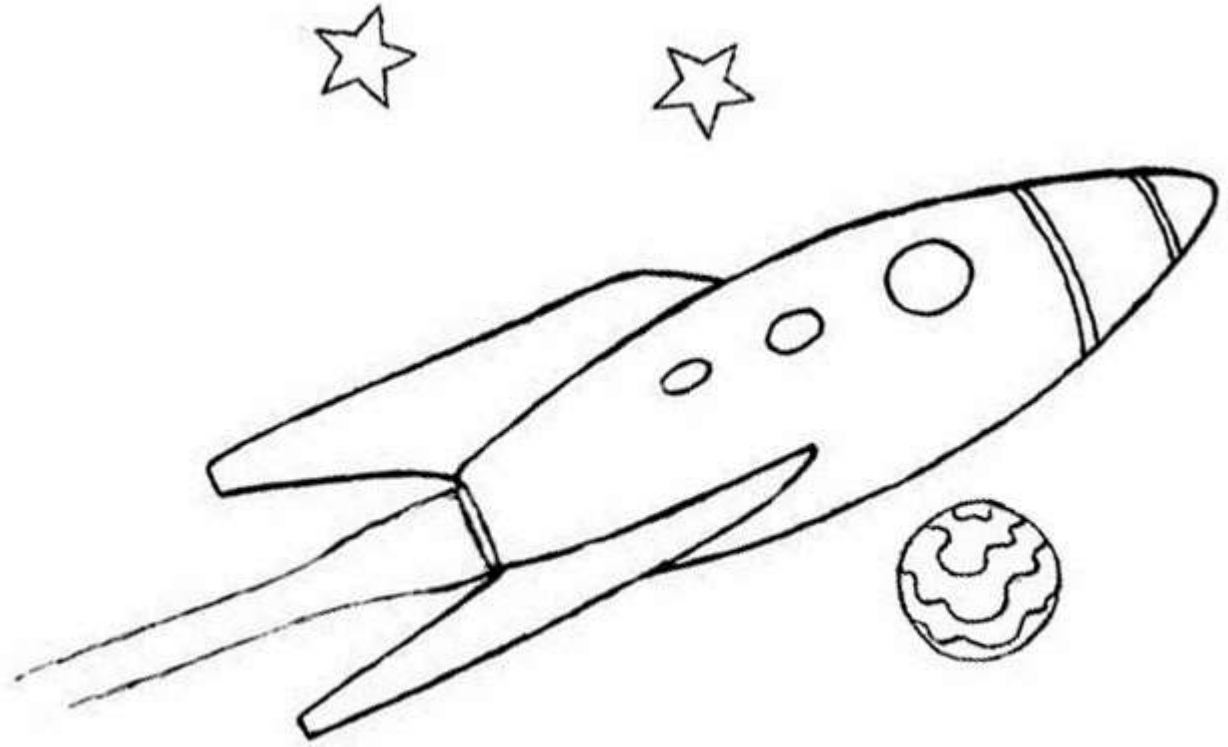

صاروخ

استخدم الصلصال في رسم الحرف :



ض



ضفدع

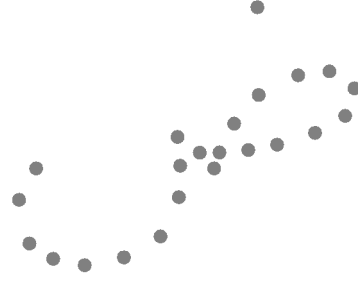
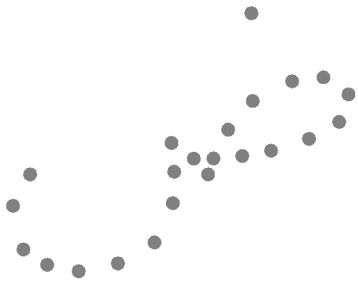
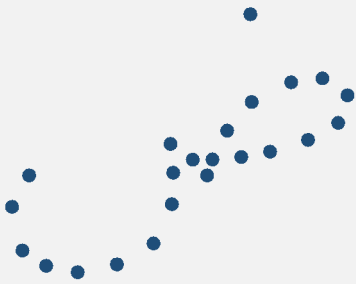



ظ



ظ



ظ

قم بتلوين الرسمة التالية :

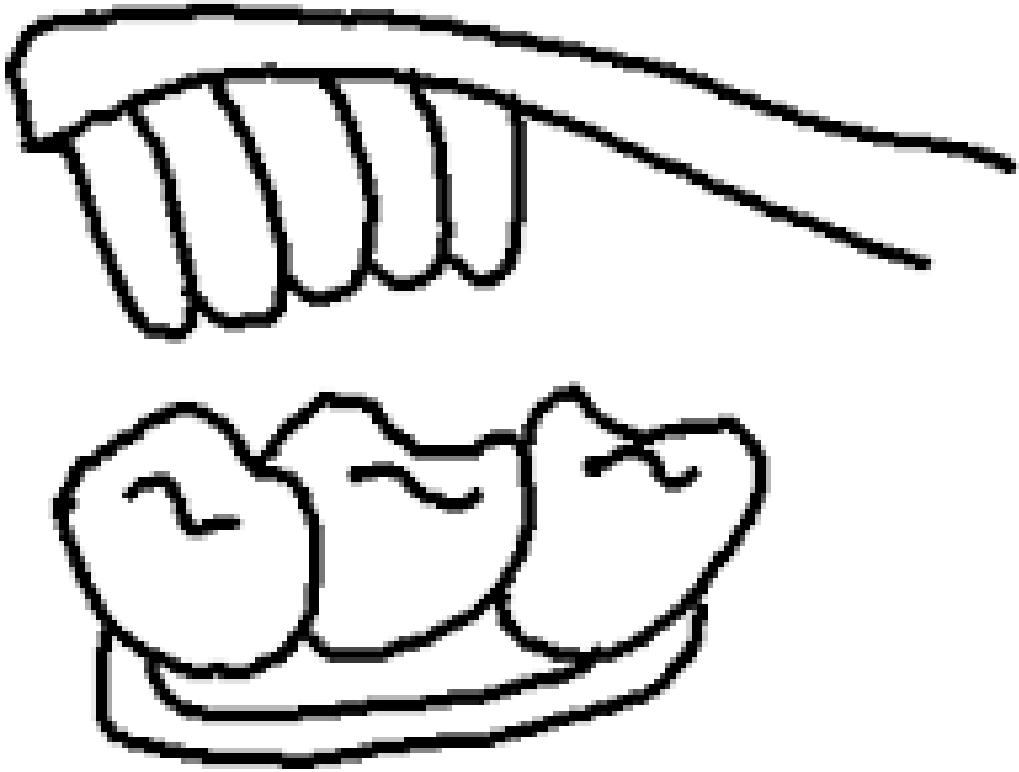

ضرس

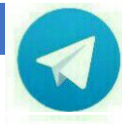

استخدم الصلصال في رسم الحرف :

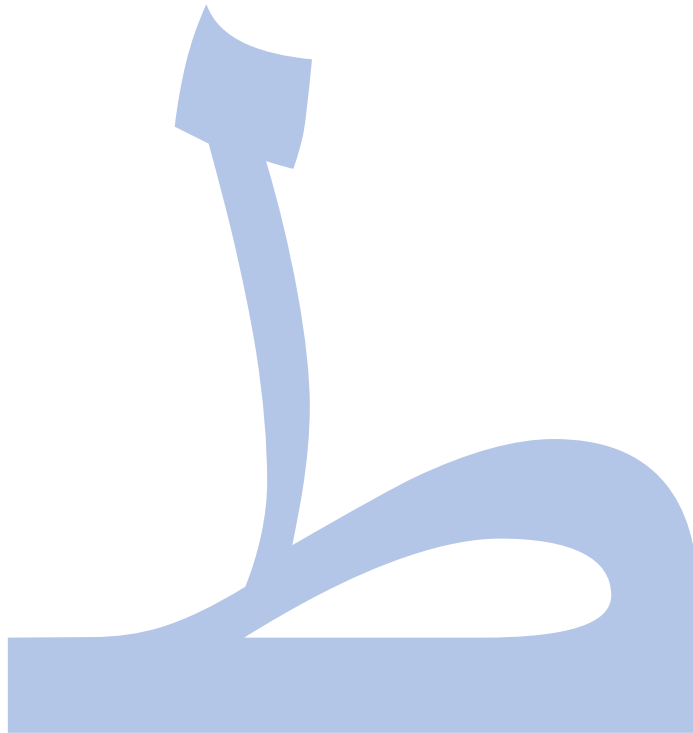



طائرة

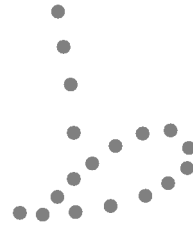
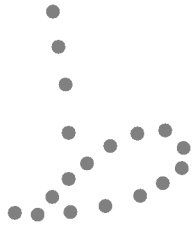



ط



ظ



ظ

قم بتلوين الرسمة التالية :

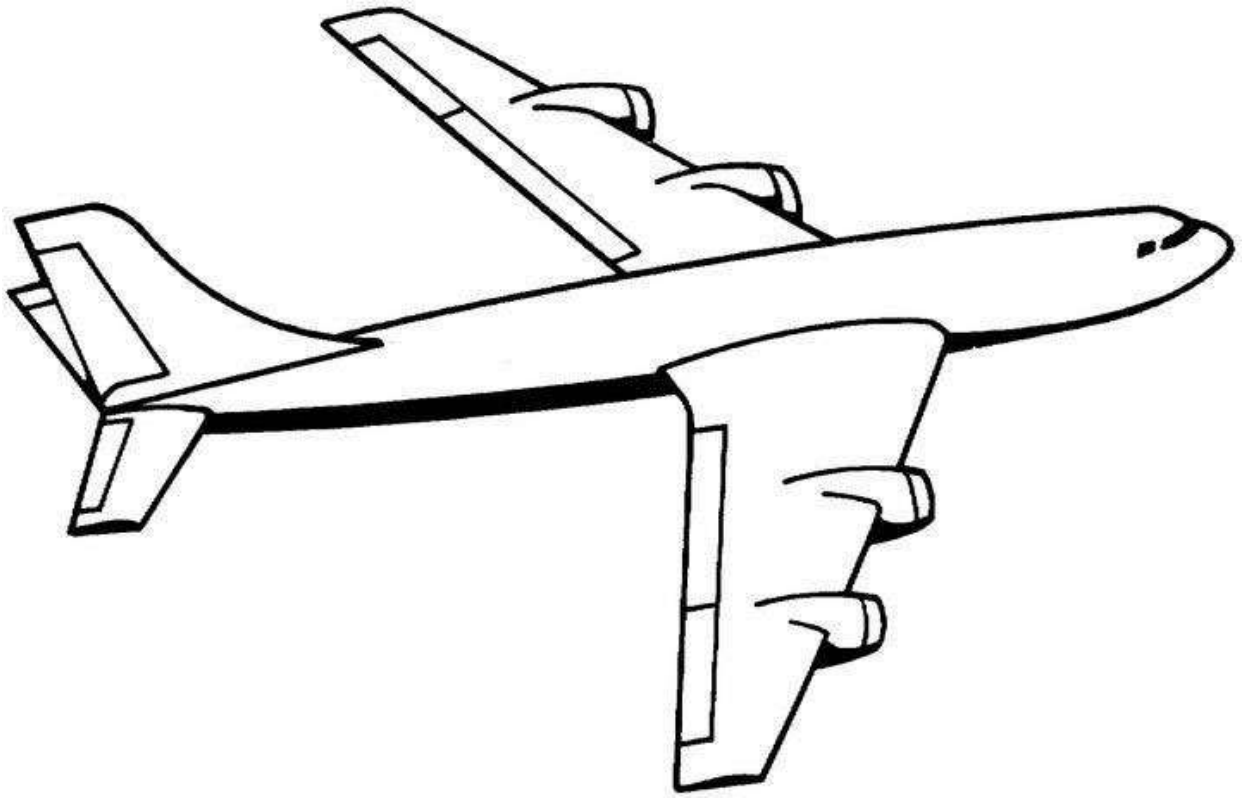

طائرة

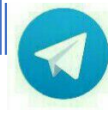

استخدم الصلصال في رسم الحرف :



ظ



ظرف

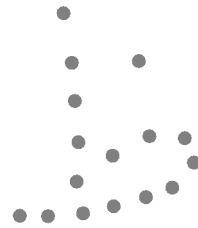
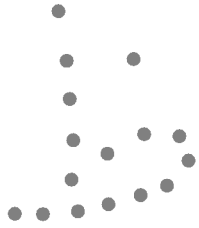



ظ



ظ



ظ

قم بتلوين الرسمة التالية :

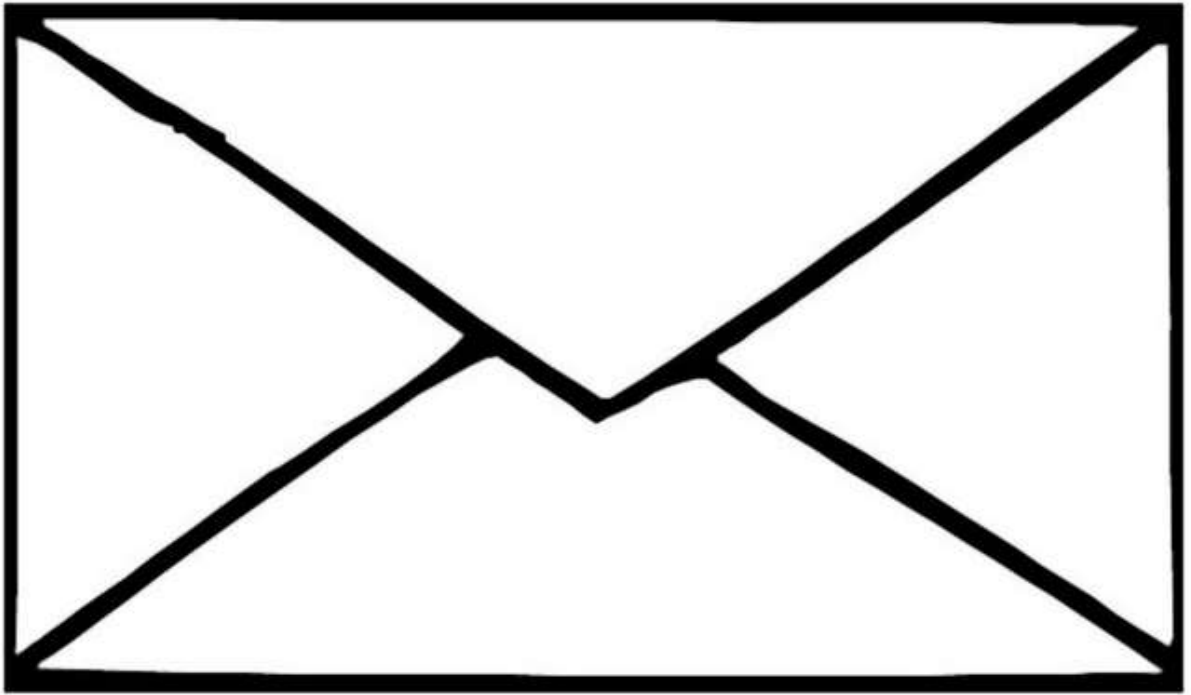

ظروف



استخدم الصلصال في رسم الحرف :



ع



عين

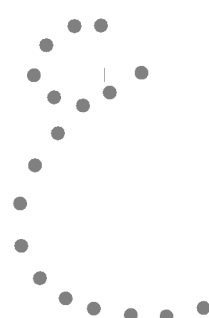
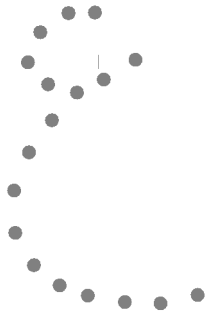
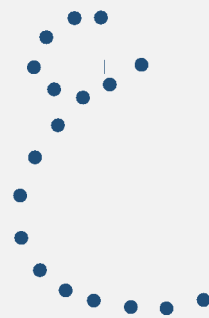
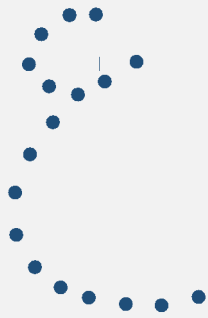



ع



ع



ع

قم بتلوين الرسمة التالية :



عنب

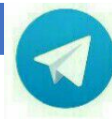

استخدم الصلصال في رسم الحرف :



ع



غراب

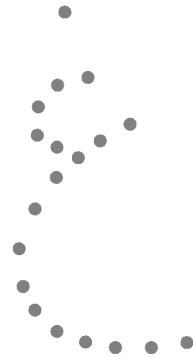
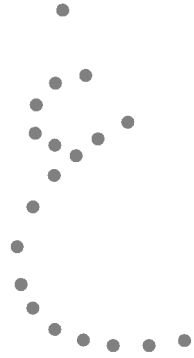



ر



ز



س

قم بتلوين الرسمة التالية :

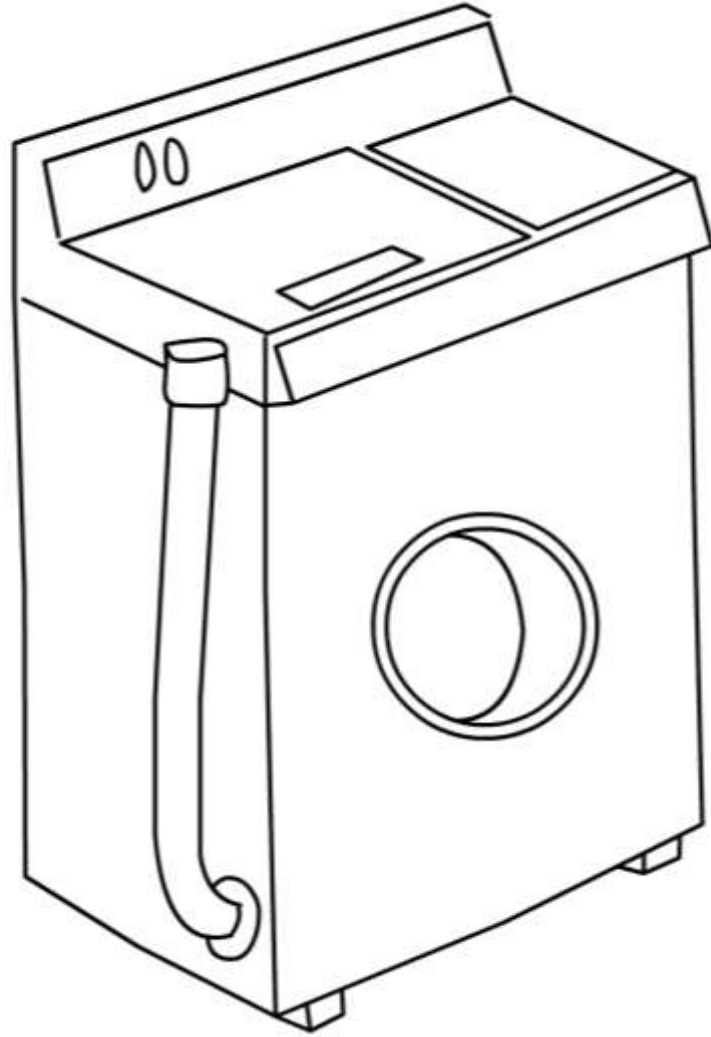

غسالة



استخدم الصلصال في رسم الحرف :



ف



فراولة

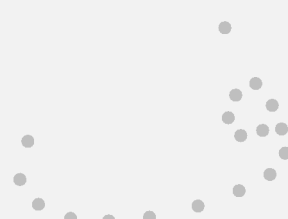
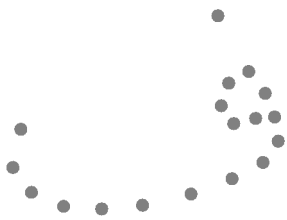



وا



وا



وا

قم بتلوين الرسمة التالية :

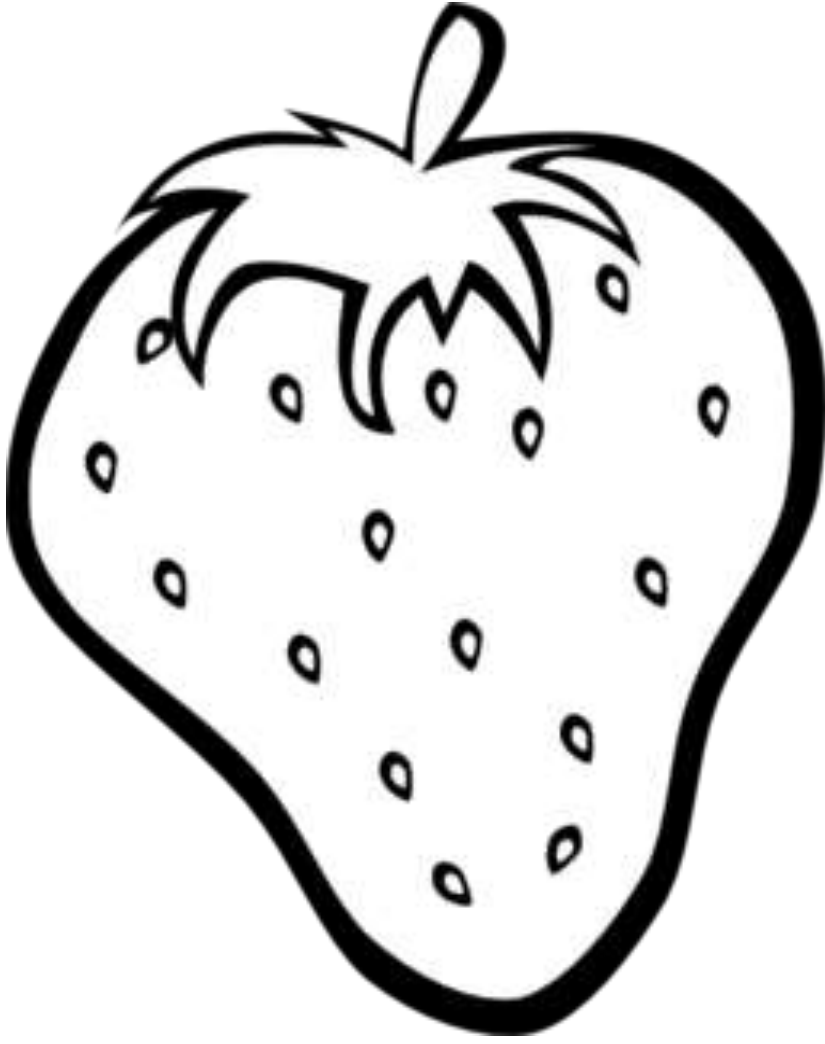

فراولة



استخدم الصلصال في رسم الحرف :



ق



قظ

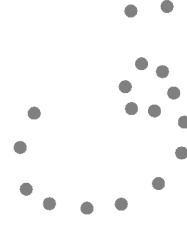
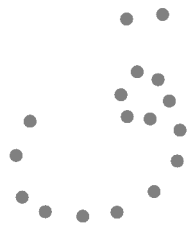



اِفْ



اِفْ



اِفْ

قم بتلوين الرسمة التالية :

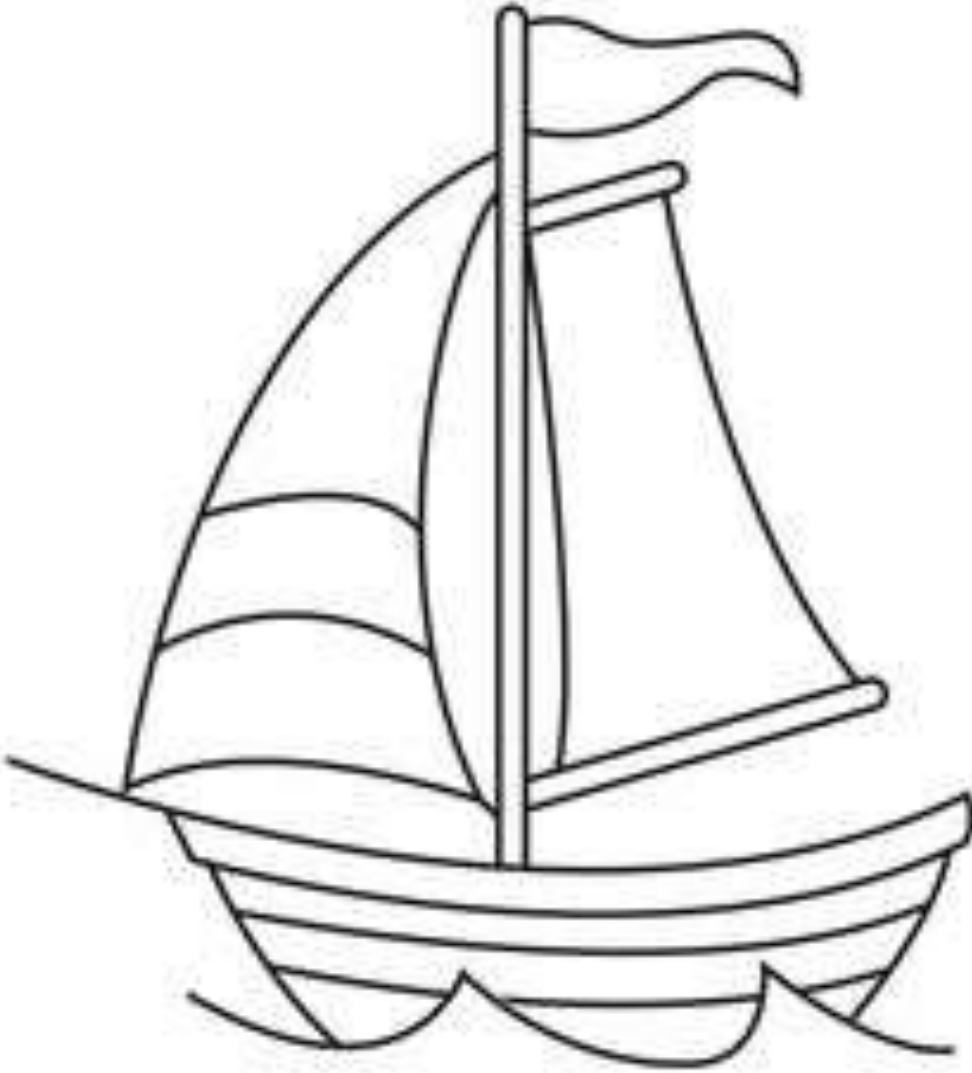

قارب



استخدم الصلصال في رسم الحرف :



أ



كتاب

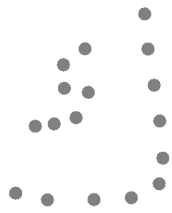



أى



أى



أى

قم بتلوين الرسمة التالية :

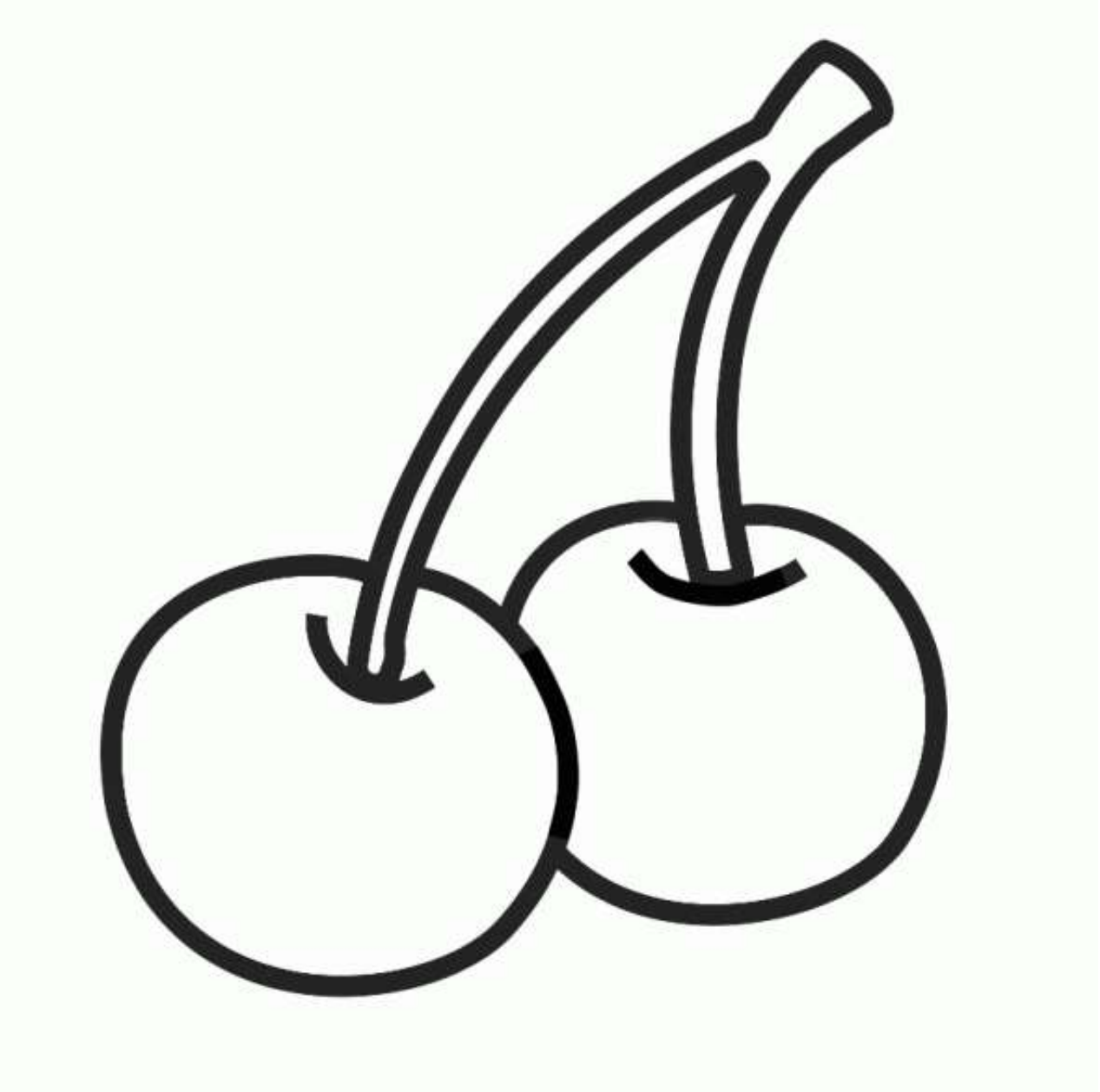

كز

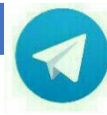

استخدم الصلصال في رسم الحرف :

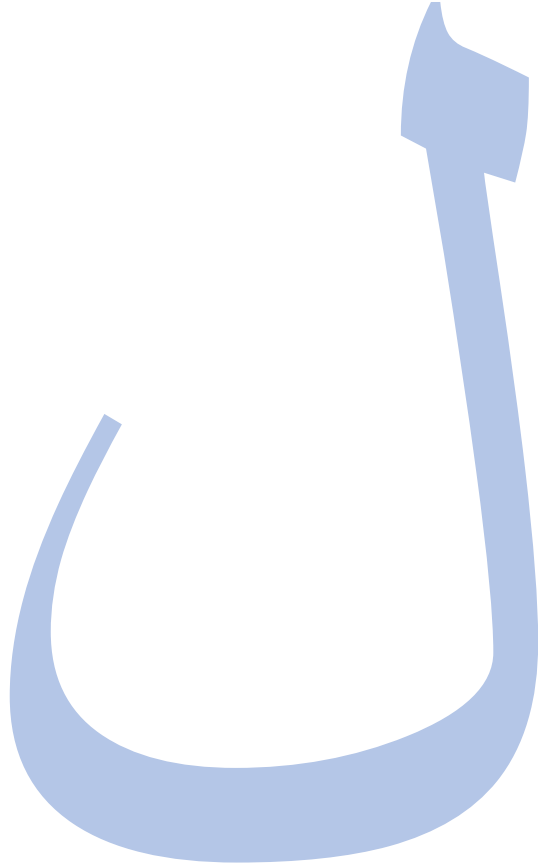

ل



ليمون





ا



ب



ك

قم بتلوين الرسمة التالية :

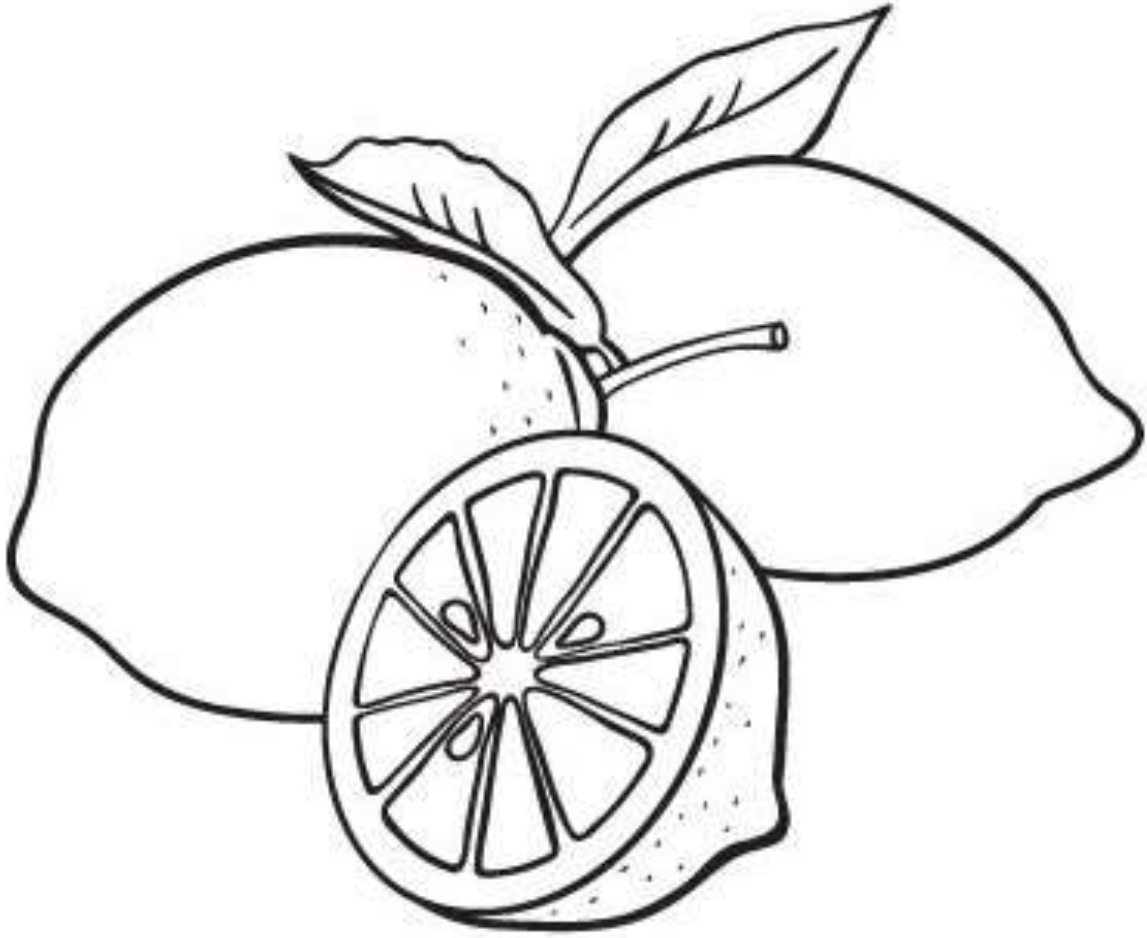

ليمون



استخدم الصلصال في رسم الحرف :



ح



ملعقة





ا
ح



ح
ا



ه
ح

قم بتلوين الرسمة التالية :

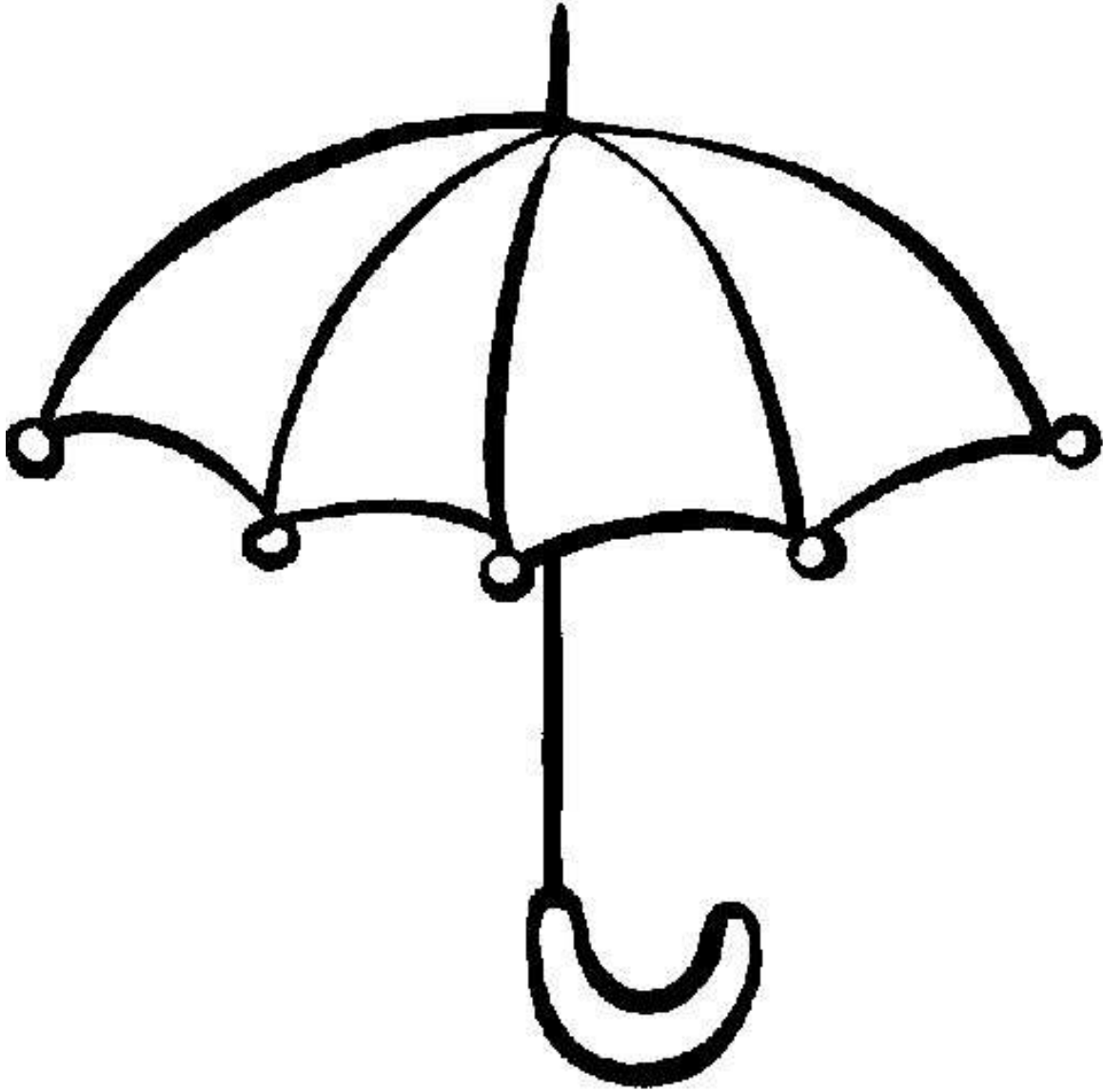

مظلة



استخدم الصلصال في رسم الحرف :



ن



نمر





ا



ب



م

قم بتلوين الرسمة التالية :

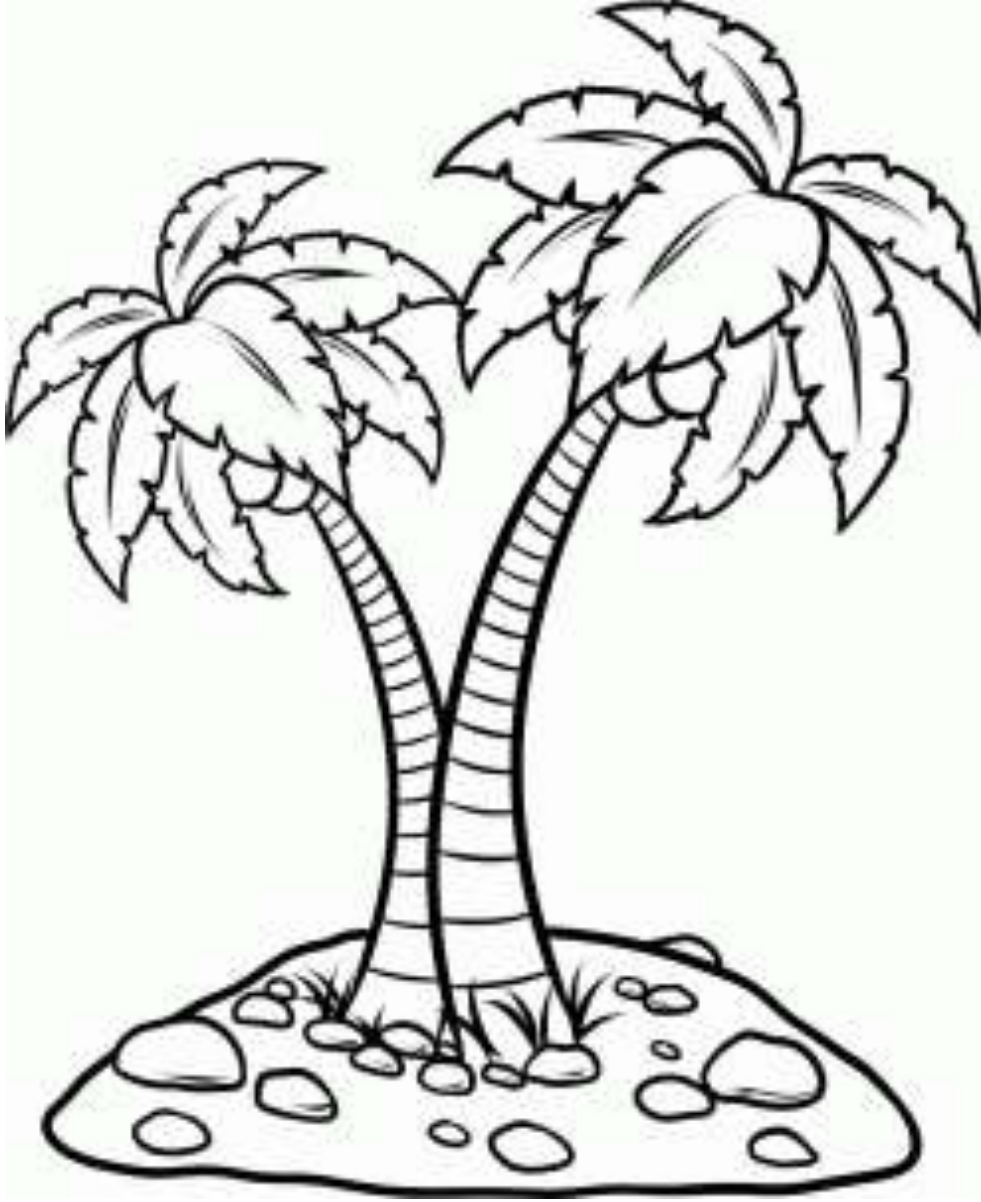

نخلة

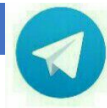

استخدم الصلصال في رسم الحرف :

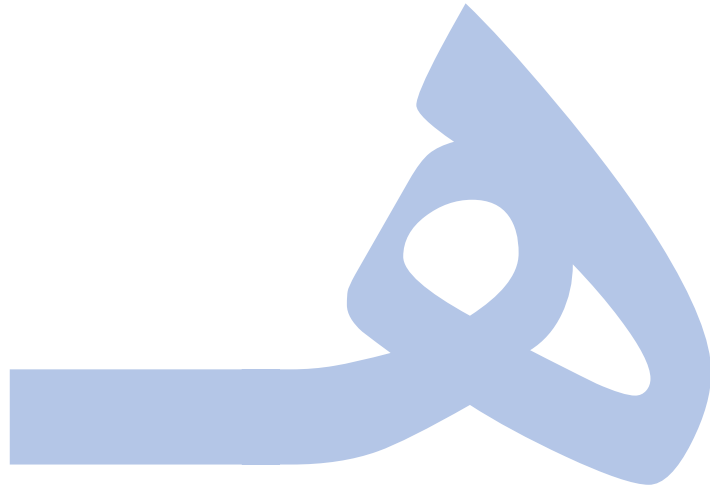

هـ



هدية

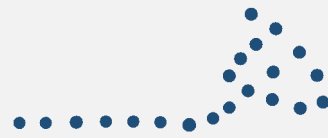



ها



ها



ها

قم بتلوين الرسمة التالية :



هدية

استخدم الصلصال في رسم الحرف :



و



وحيد القرن





وا



وا



وا

قم بتلوين الرسمة التالية :

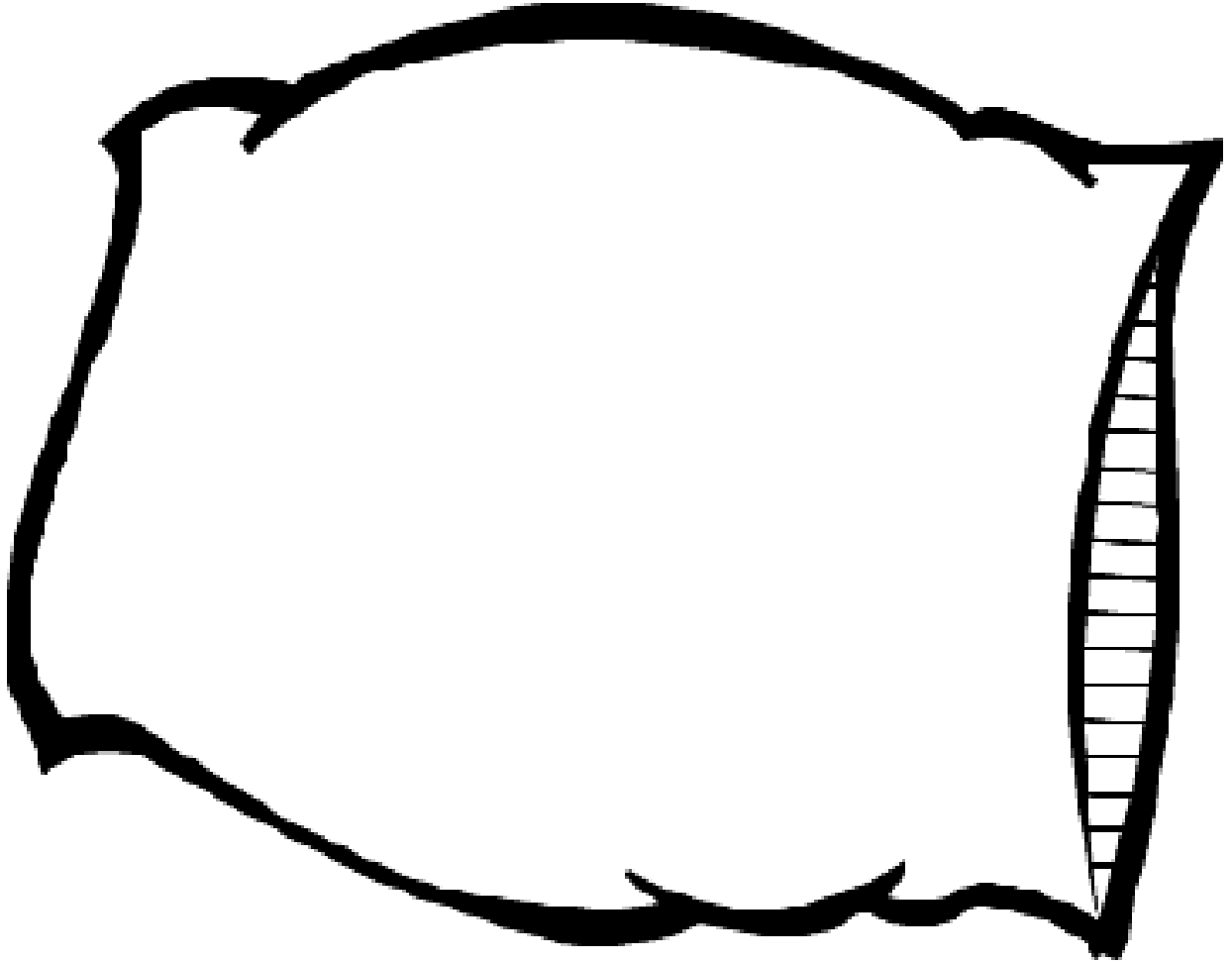

وسادة

استخدم الصلصال في رسم الحرف :



ي



ي

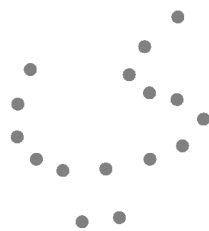
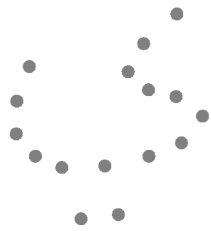
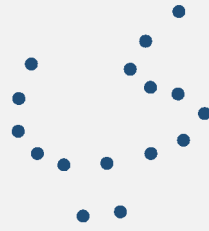



يا



يا



يا

قم بتلوين الرسمة التالية :

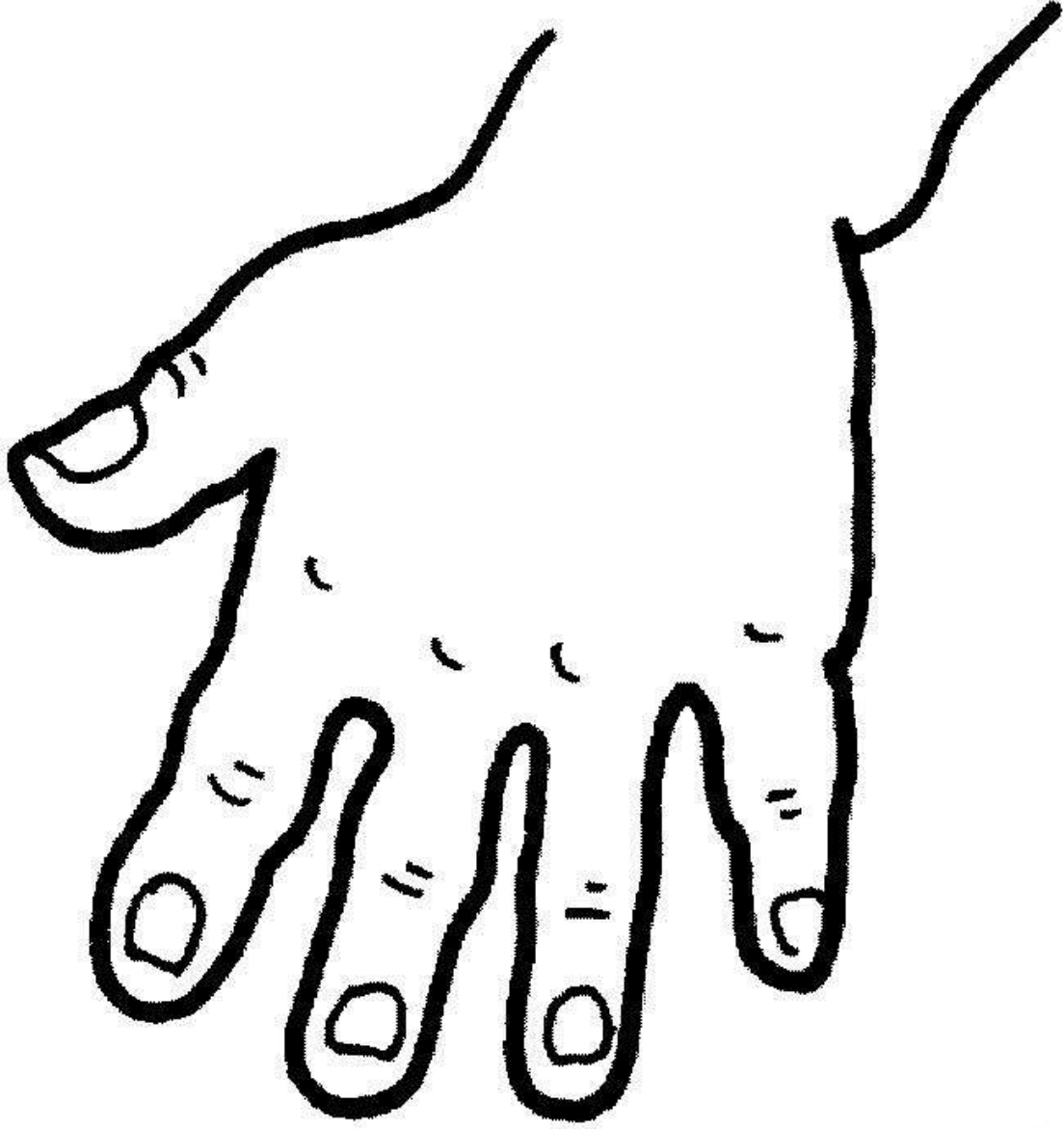

يد





 **@Arabic_Books**